

TPA Training Course

Corrosion Management in the Oil & Gas Industry

Marcel ROCHE

Part 3

**Arkhangelsk State Technical University
April, 6 – 10, 2009**

Corrosion Management in the Oil & Gas Industry

Cathodic protection and associated coatings

Corrosion Management in the Oil & Gas Industry

Cathodic Protection

Principles, criteria, limitations

Principles of cathodic protection (CP)

- ◆ It applies to fight against “**wet corrosion**” (electrochemical process) produced by liquid water in contact with metal
- ◆ Cost efficient in **continuous moderately corrosive electrolytic environments** : waters (mainly seawater), soils (and marine mud), concrete
- ◆ Cathodic protection is **potentially efficient against any kind of electrochemical corrosion**, including **galvanic corrosion, MIC, fatigue-corrosion, Stress corrosion cracking, ...**

Definitions

From **ISO 8044 Standard** " Corrosion of metals and alloys – Principal terms and definitions ":

- ◆ **Electrochemical Protection**: technique of protection against corrosion through electrical control of corrosion potential.
- **Cathodic Protection**: Electrochemical Protection through decrease of corrosion potential at a level for which the corrosion rate of metal is significantly reduced.

Principle of cathodic protection

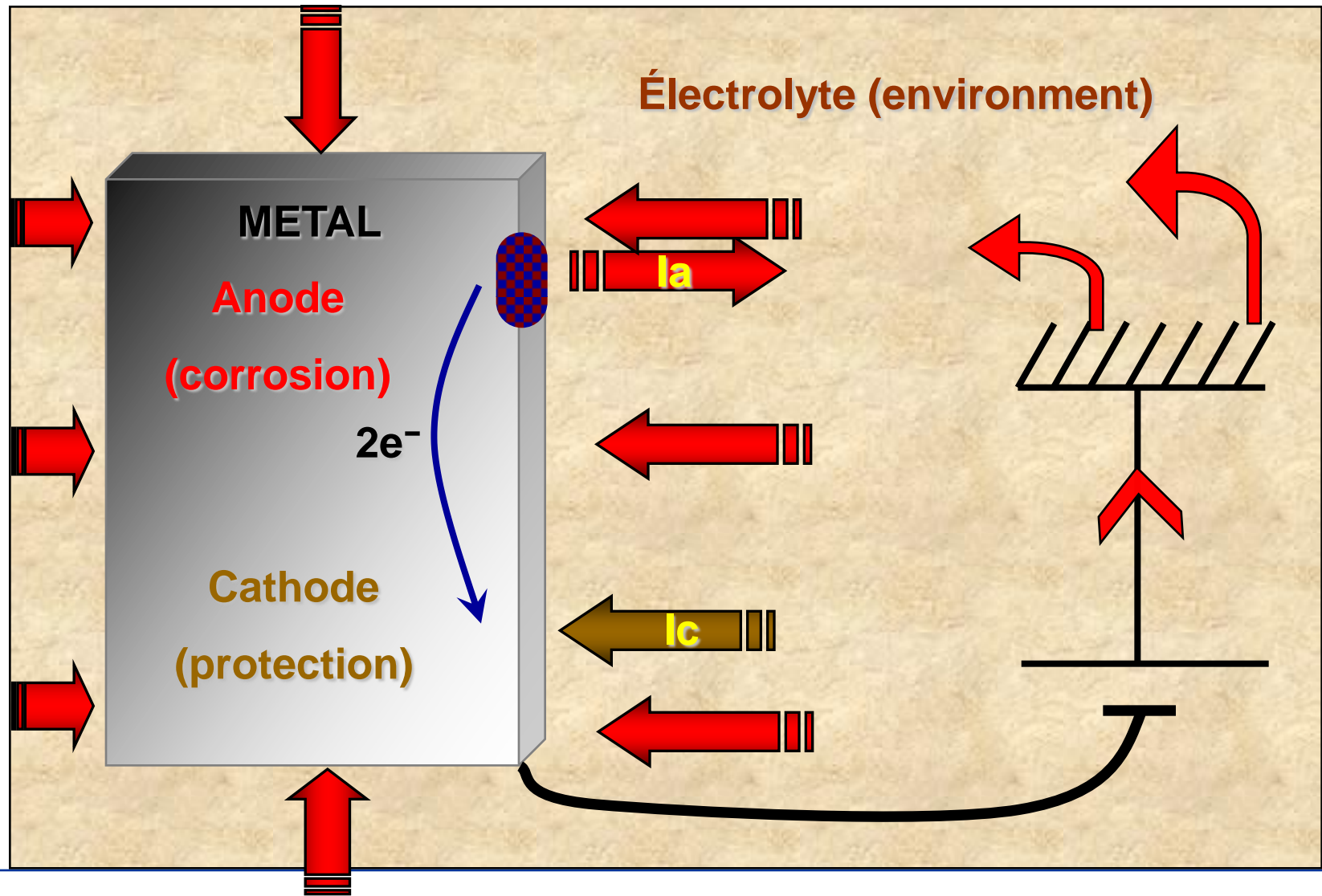

Principles of cathodic protection

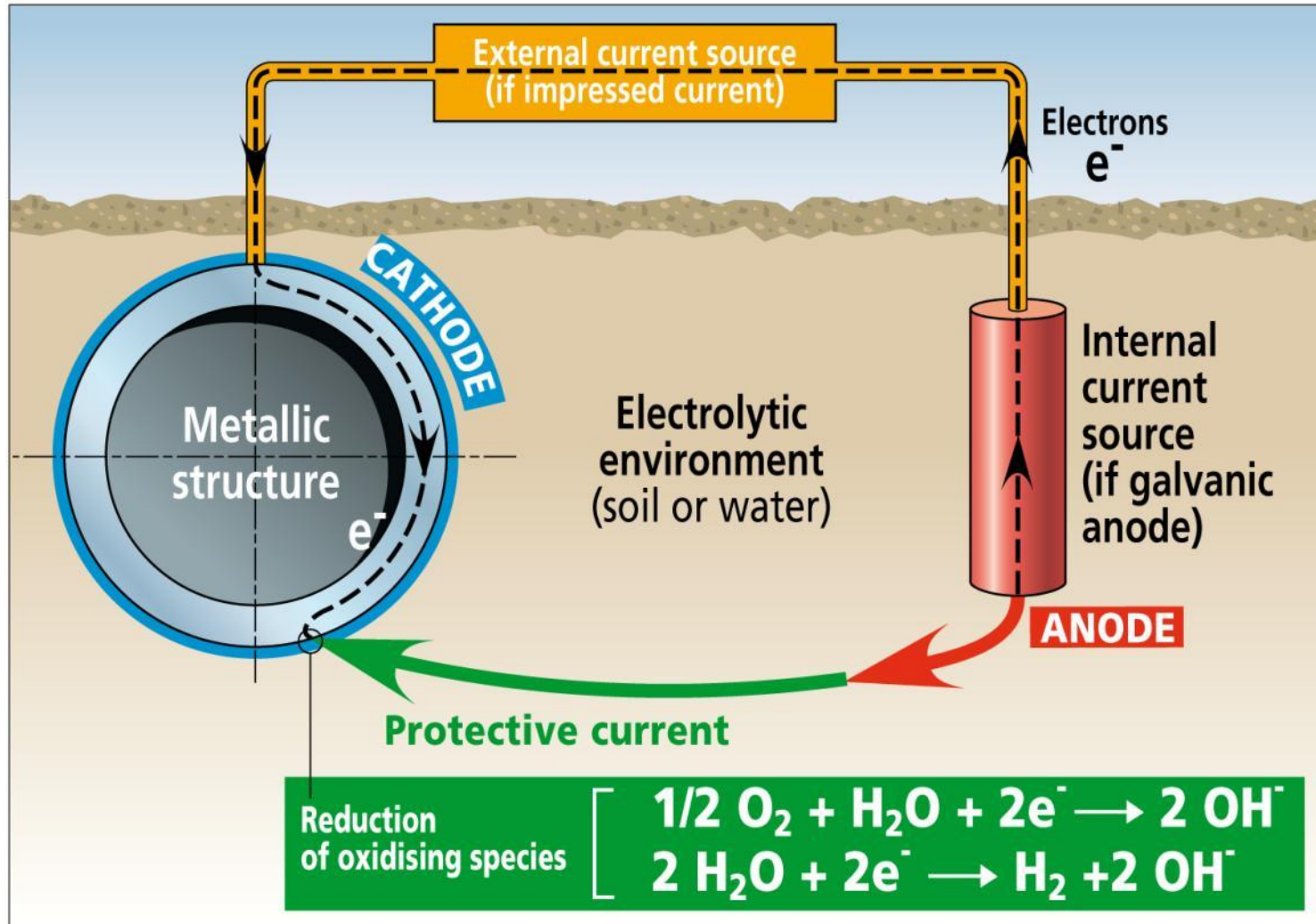

Principle of cathodic protection

- ◆ Cathodic Protection is aimed at **reducing corrosion through metal - electrolyte electrochemical potential decrease (towards more negative values), which:**
 - **reduces anodic reaction rate (oxidation of metal)**
 - $\text{Fe} \rightarrow \text{Fe}^{2+} + 2\text{e}^-$
 - **increases cathodic reaction(s) rate(s) (reduction of oxidising species present in the electrolyte)**
 - $\frac{1}{2} \text{O}_2 + \text{H}_2\text{O} + 2\text{e}^- \rightarrow 2 \text{OH}^-$
 - $2 \text{H}^+ + 2\text{e}^- \rightarrow 2\text{H}$
 - $2 \text{H}_2\text{O} + 2\text{e}^- \rightarrow 2 \text{OH}^- + 2\text{H}$

Principles of cathodic protection

Cathodic Protection (may) provoke:

- ◆ Always an **alkalinisation** of aqueous phase at the metal surface
 - **positive effects** : precipitation of protective calcareous deposits at the metal surface
 - **detrimental effects**: blistering of sensitive paints, disbonding of coatings, alkaline corrosion of amphoteric metals
- ◆ Sometimes significant formation of **atomic hydrogen**
 - **detrimental effects**: embrittlement of sensitive alloys, safety problems inside protected capacities

Principles of cathodic protection

- ◆ The decrease of potential at a sufficient level is achieved through the flow of a D.C. ("cathodic") current from the aqueous phase (electrolyte) to the metal to protect
- ◆ This current is produced by one of these methods:
 - galvanic coupling with a less noble alloy: **Galvanic Systems with sacrificial anodes based on Mg, Zn or Al**
 - direct current (dc) impressed by an external electric power source (transformer/rectifier, photovoltaic solar cells,...) using anodes which may be consumable, semi-inert or inert: **Impressed Current Systems**

Principles of cathodic protection

- ◆ Cathodic current flows out of anodes always through oxidation electrochemical reactions
- ◆ It may be **oxidation of metal**, when consumable:



- ◆ It may be **oxidation of some chemical species of electrolyte** around anode:



- ◆ Environment becomes oxidising and acidic, consequently corrosive for polymeric materials used for electrical insulation of connections

CP with galvanic anodes

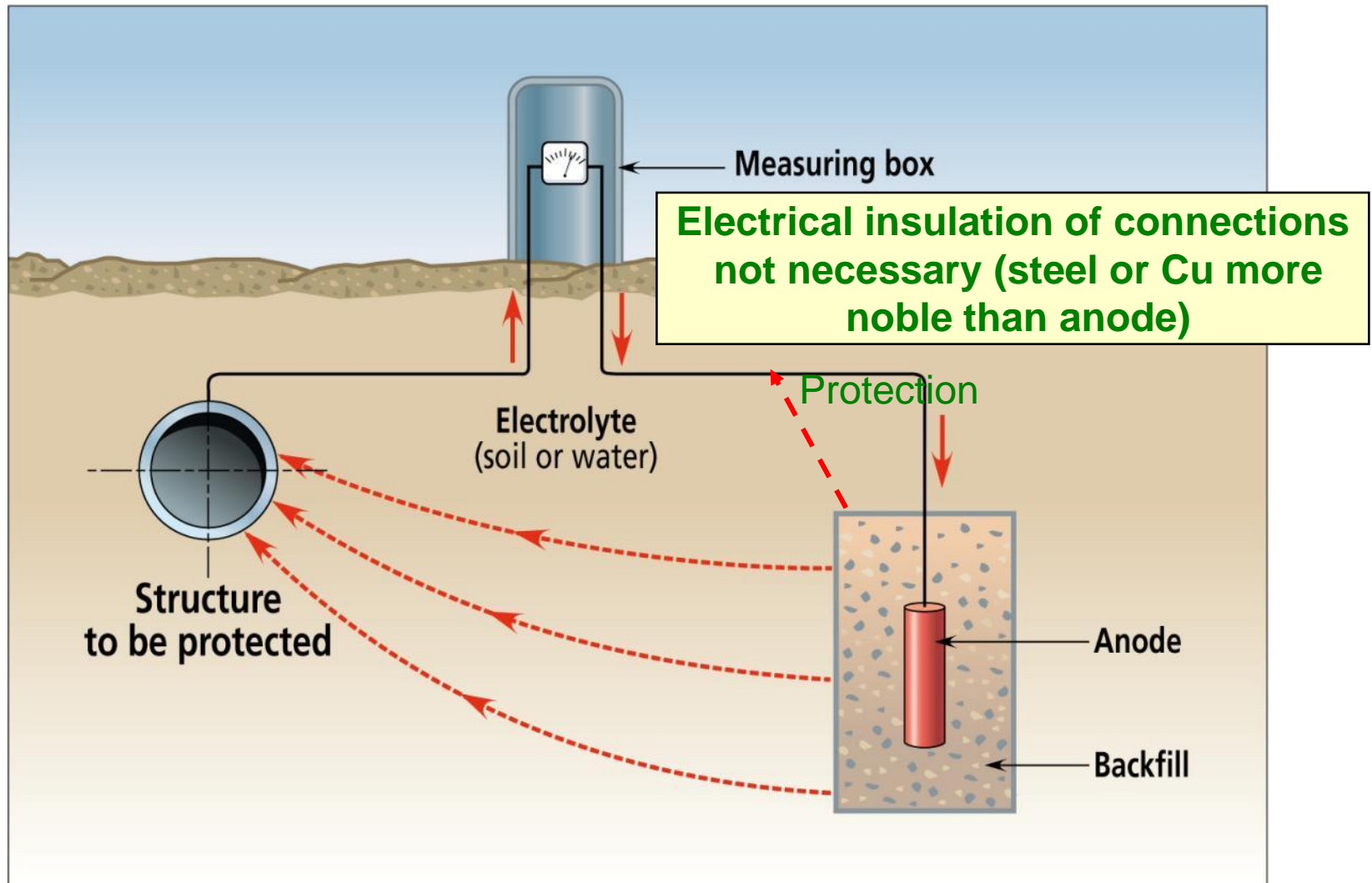

CP with impressed current

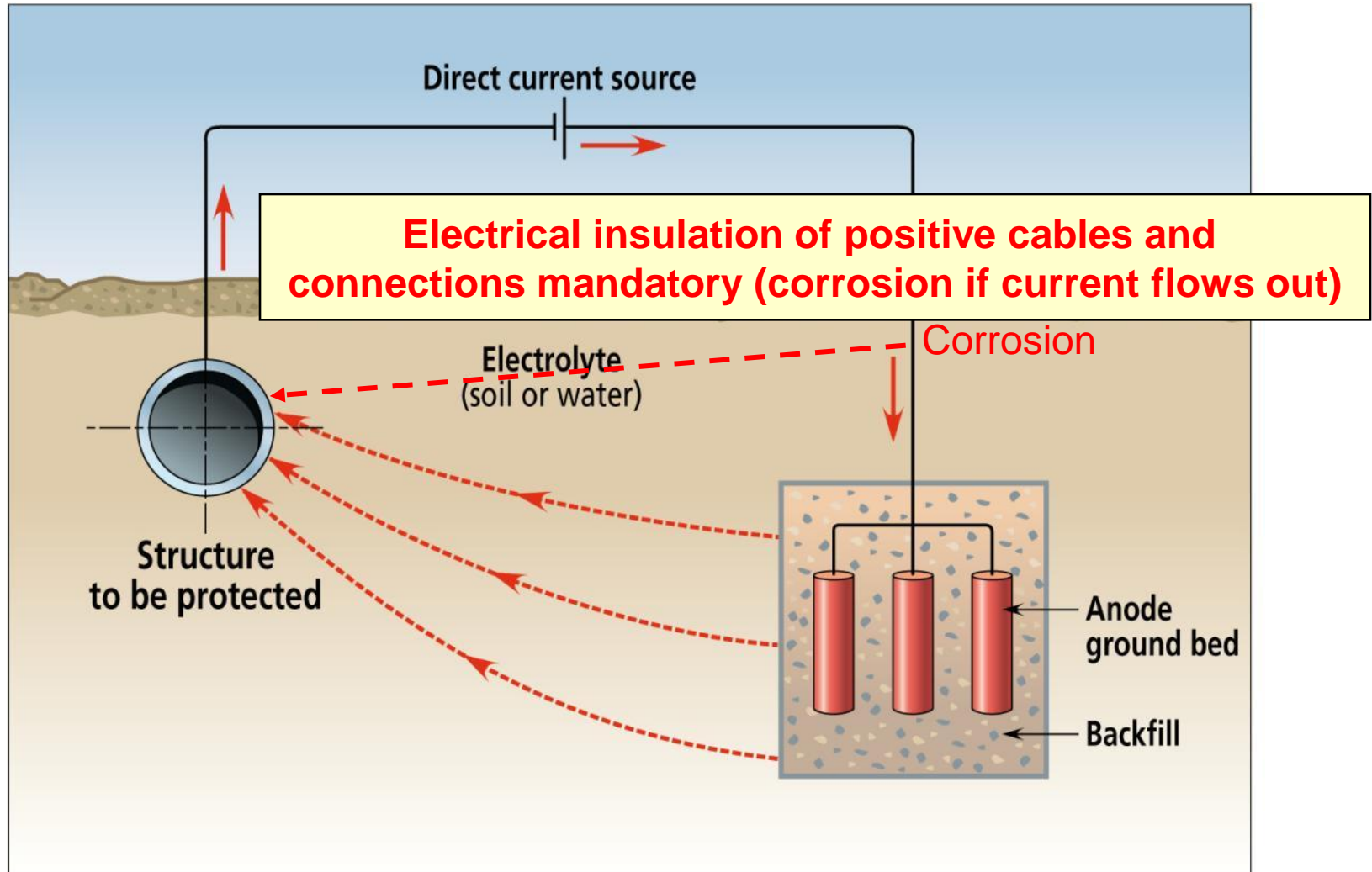

Criteria for evaluation of CP efficiency

- ◆ Protection criteria are based on theory (thermodynamics and kinetics) but adapted from field practical experience
- ◆ Main basic criterion for carbon or low-alloy steels:
 - in soils: $< -0.85 \text{ V} / \text{saturated Cu-CuSO}_4$ (limited to $> -1.2 \text{ V}$ to prevent H embrittlement and coating disbonding)
 - in seawater and brackish waters: $< -0.80 \text{ V} / \text{Ag-AgCl-seawater}$ (limited to $> -1.1 \text{ V}$ for preventing increase of propagation rate of cracks)

Criteria for evaluation of CP efficiency

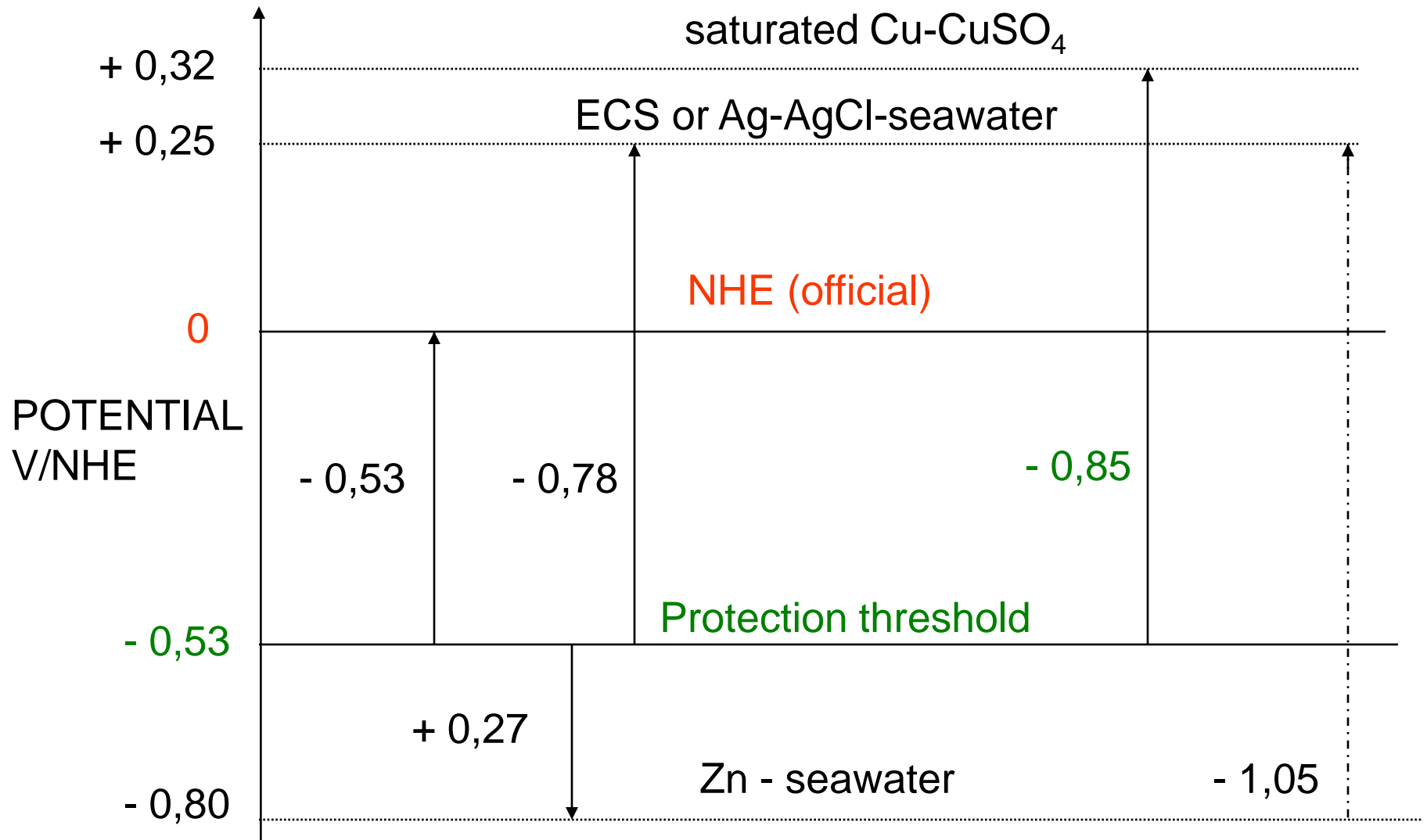

Criteria for evaluation of CP efficiency

Modulations of criterion around the basic value:

◆ in case of “**high**” bacterial activity” (SRB) in anaerobic environments or **temperature** $> 60^{\circ}\text{C}$:

$< -0.95 \text{ V}$ / saturated **Cu-CuSO₄** or -0.90 V / **Ag-AgCl-seawater**

◆ in **very resistive sandy soils**:

$< -0.75 \text{ V}$ between 100 and 1000 Ohm.m and

$< -0.65 \text{ V}$ / sat. **Cu-CuSO₄** above 1000 Ohm.m (EN 12954, ISO 13623 and ISO 15589-1)

100 mV shift criteria

Alternatively, some standards (NACE, ISO 15589-1) specify a minimum **potential shift of 100 mV** (NACE to extend to 150 mV when SRB activity or temperature is high)

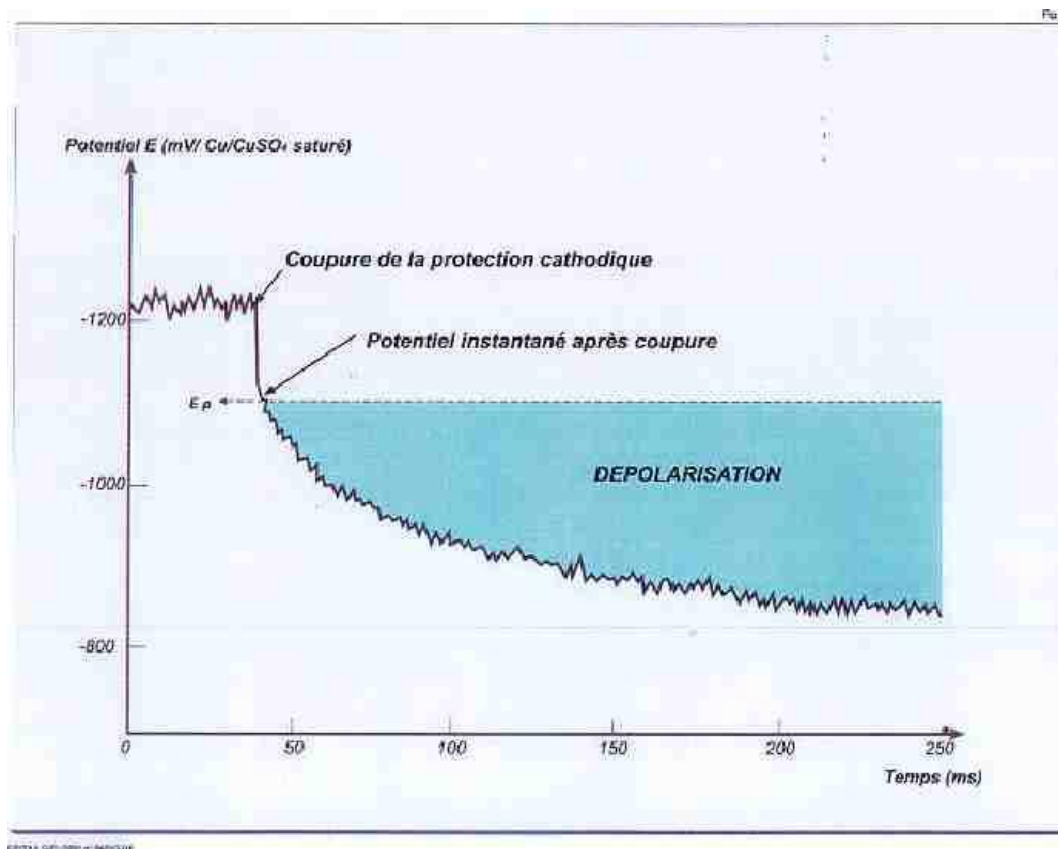

Criteria for CP of stainless steels

- ◆ Polarisation to prevent **localised corrosions** (pitting or crevice corrosion) in chloride containing environments:

 - **0,3 to - 0,6 V/Ag-AgCl-seawater**

 - ⇒ **Stable passivation**

- ◆ **Complete protection:**

 - 0,8 V/Ag-AgCl-seawater**

 - ⇒ **Immunity**

Current densities for achieving CP

For **uncoated carbon and low-alloy steels**:

- ◆ in seawater: 60 (hot seas) to 220 mA /m² (agitated cold seas)

**Current density increases when O₂ access increases
(hence when temperature decreases or turbulence increases)**

- ◆ in sea bottom muds: 20 to 25 mA/m²
- ◆ in soils: 10 (dry soils) to 20 (wet soils) mA/m²
- ◆ in fresh waters: 20 (stagnant cold water) to 150 (flowing hot seawater) mA/m²
- ◆ in concrete: < 1 (preventive) to 10 (curative) mA/m²

Current densities for achieving CP

The formation of a “**calcareous deposit**” (insoluble salts of calcium and magnesium) in seawater reduces current density:

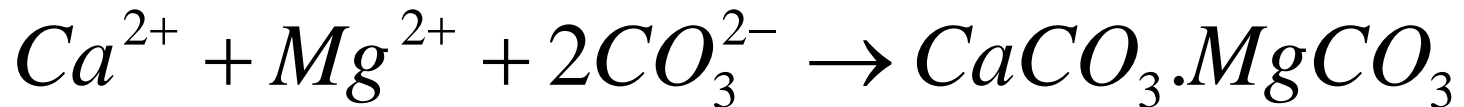
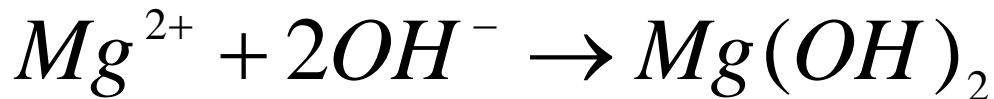
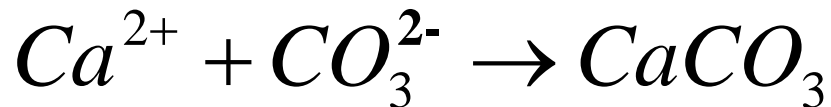
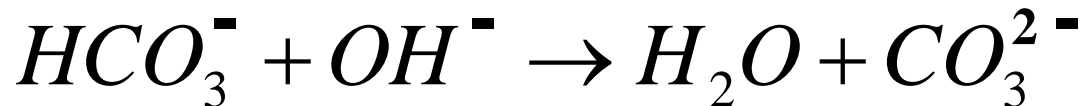

Current densities for achieving CP

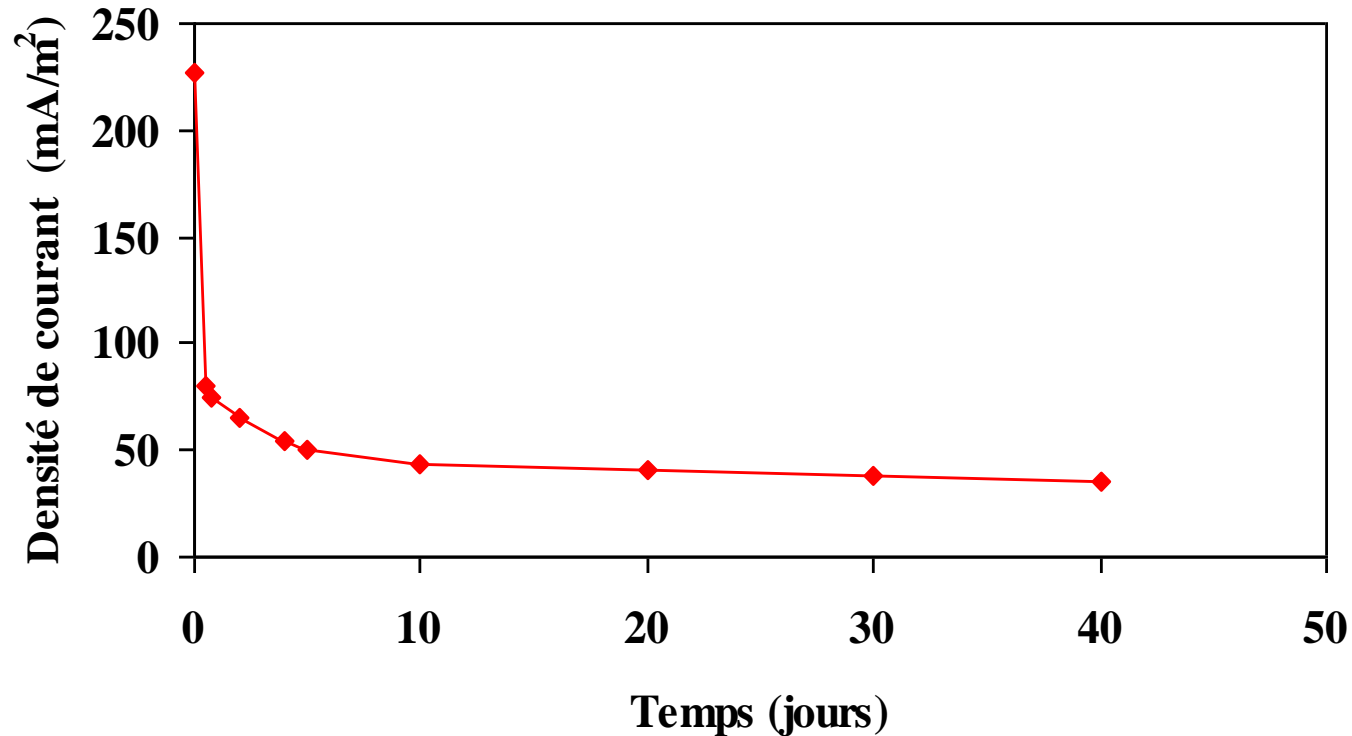

Evolution of current density at a location of an experimental structure (K node) cathodically protected vs. Immersion time - Effect of calcareous deposits

Coatings associated with CP

Aims of associated coatings:

- ◆ **Complementary protection** to cathodic protection in order to ensure one of the following roles:
 - limit current consumption, hence the weight of anodes
 - produce a rapid polarisation,
 - ensure a long span of CP in complex geometry areas,
 - ensure a better homogeneity of current over the structure,
 - reduce global cost of protection.
- ◆ **Main protection (passive)** against corrosion seconded by a cathodic protection (active) at places where the coating is damaged
- ◆ The coating system has to be **compatible** with cathodic protection.

Influence of coatings on current density

- ◆ Reduction of protective current density vs. efficiency of eventual **coating** (initial and after ageing): notions of **coating breakdown factor**:
 - $x = 0$ when coating effectiveness is 100 %
 - $x = 1$ when no (more) coating
- ◆ **This is the most difficult parameter to assess**
- ◆ pipelines coatings : from 0.2 à 20% , depending on pipeline plant and field joint coatings
- ◆ paint coating systems: from 2 to 50 %

Limitations for use and efficiency of cathodic protection

Absence of continuity or bad electrical continuity:

- ◆ **in the electrolyte** (ionic conduction): intermittent contacts, shielding effect (disbonded coatings, thermal insulation sheaths)
====> lack of protection
- ◆ **in the metallic structure** (electronic conduction): chains, insulating joints electrolytically short-circuited, non continuous concrete rebars, ...
====> local increase of corrosion where current flows out

Corrosion due to bad design of impressed current installed on an existing structure



Corrosion of a bracing of jacket

Corrosion at insulating joints electrolytically internally short-circuited

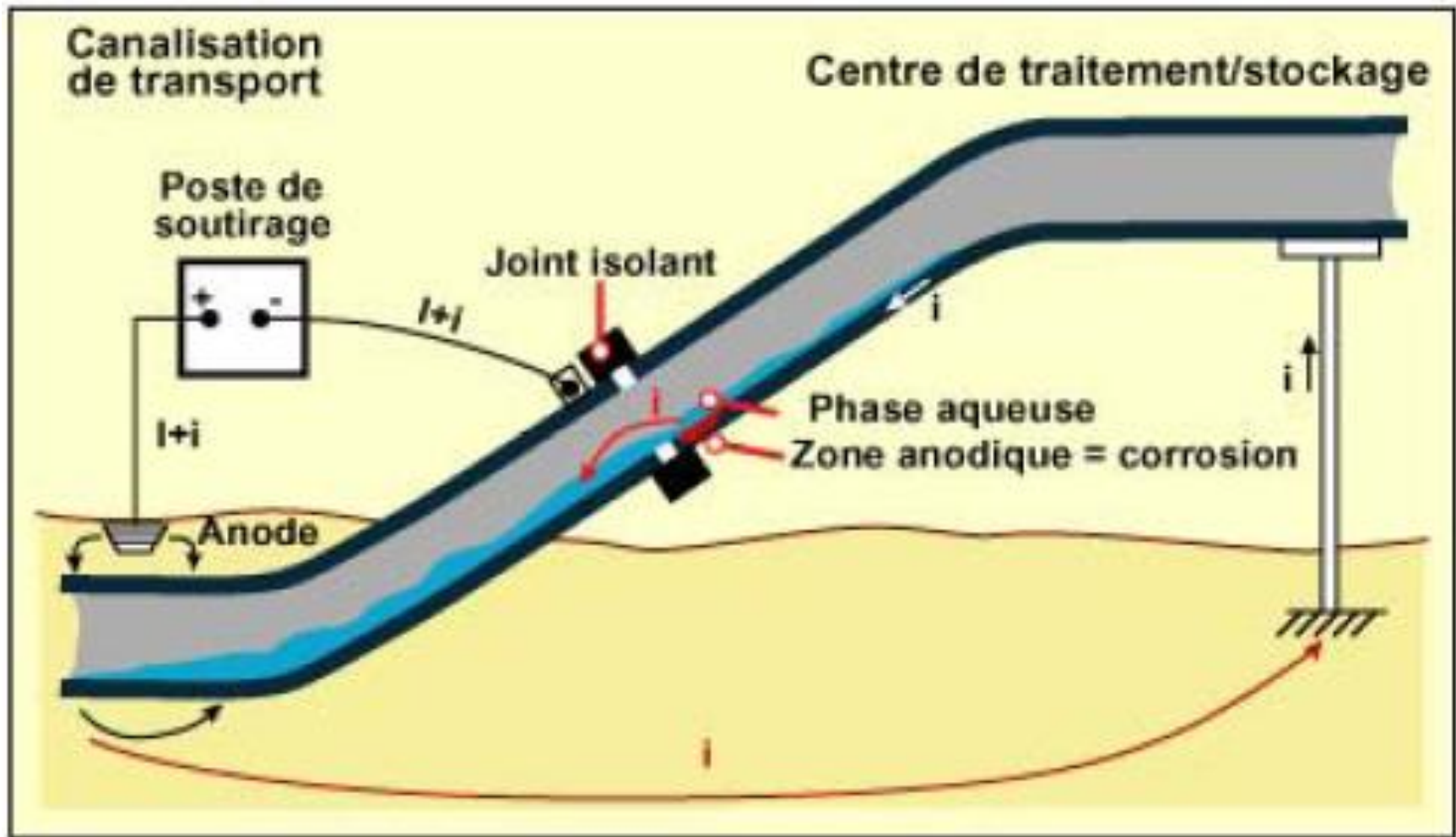

Limitations for use and efficiency of cathodic protection

Detrimental effects of cathodic protection:

- ◆ **Cathodic disbonding** (loss of adherence) of sensitive coatings
- ◆ **Hydrogen embrittlement** of conventional C Steels above yield strength (dents) or sensitive alloys (high strength steels, super martensitic 13 % Cr and duplex stainless steels, hydration of Ti)
- ◆ **Alkaline corrosion** of amphoteric metals (Al, Zn, Pb)

Cathodic disbonding of coatings

Conventional test conditions:

- Water with 3 % NaCl
- Potential of steel at -1,5 V/ECS
- Duration 28 days
- Ambient temperature (or maximum operating)

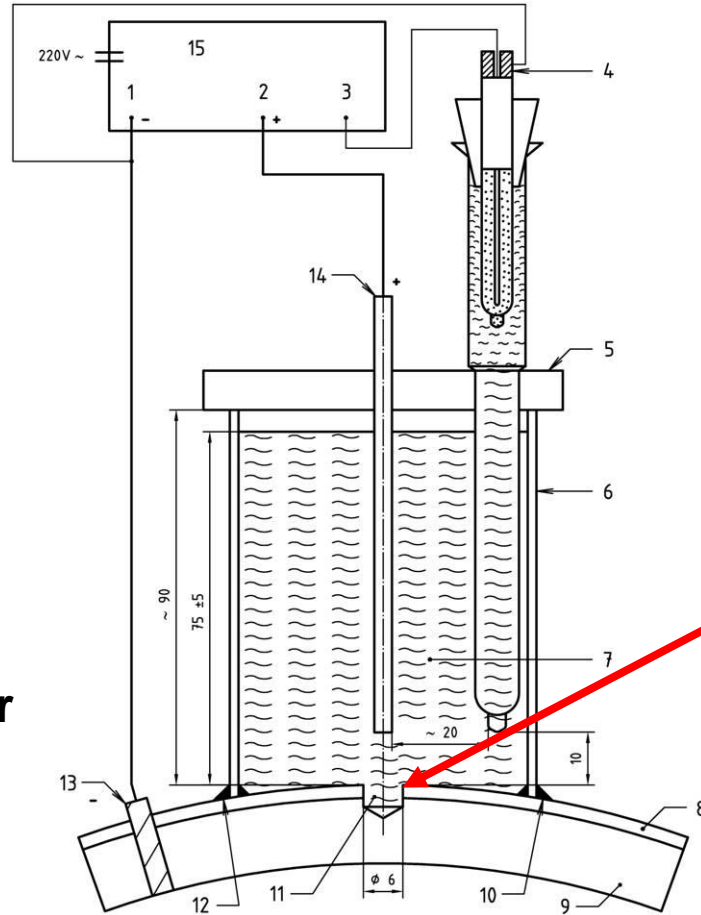

Loss of adherence around initial artificial coating defect due to OH⁻

Cathodic disbonding of coatings

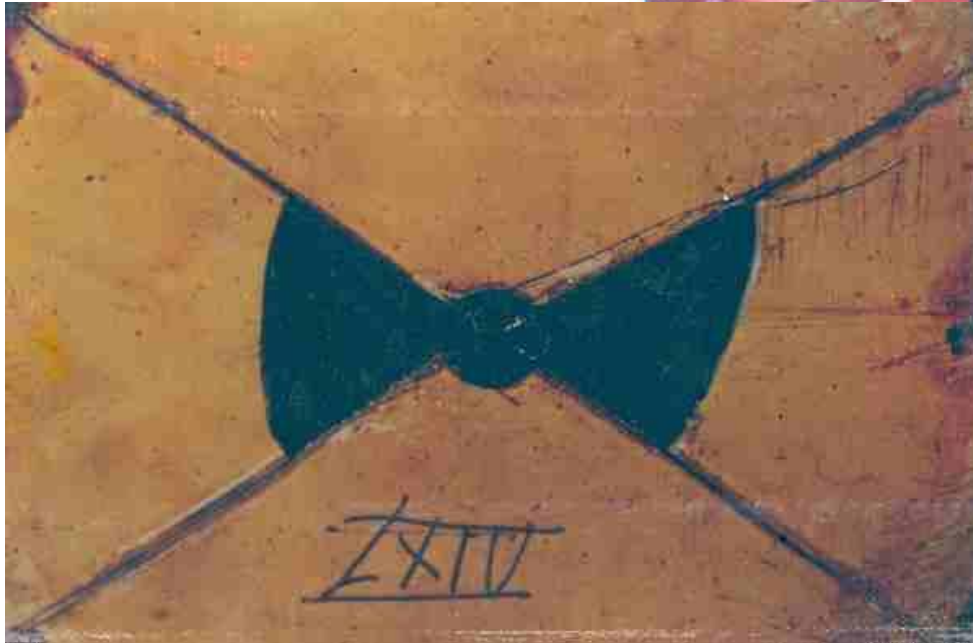

Corrosion of aluminium alloys

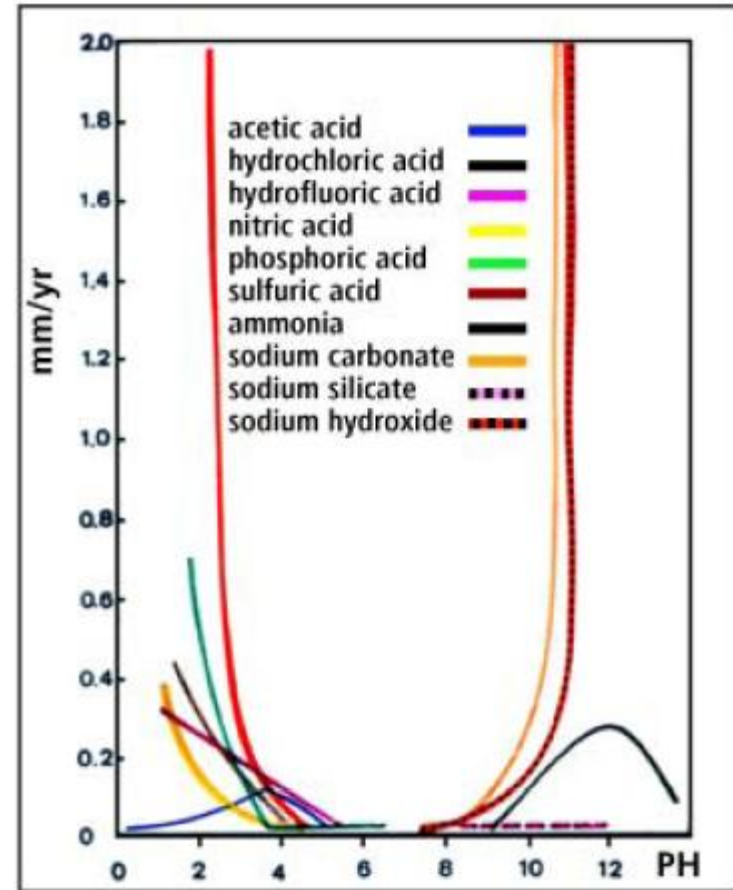
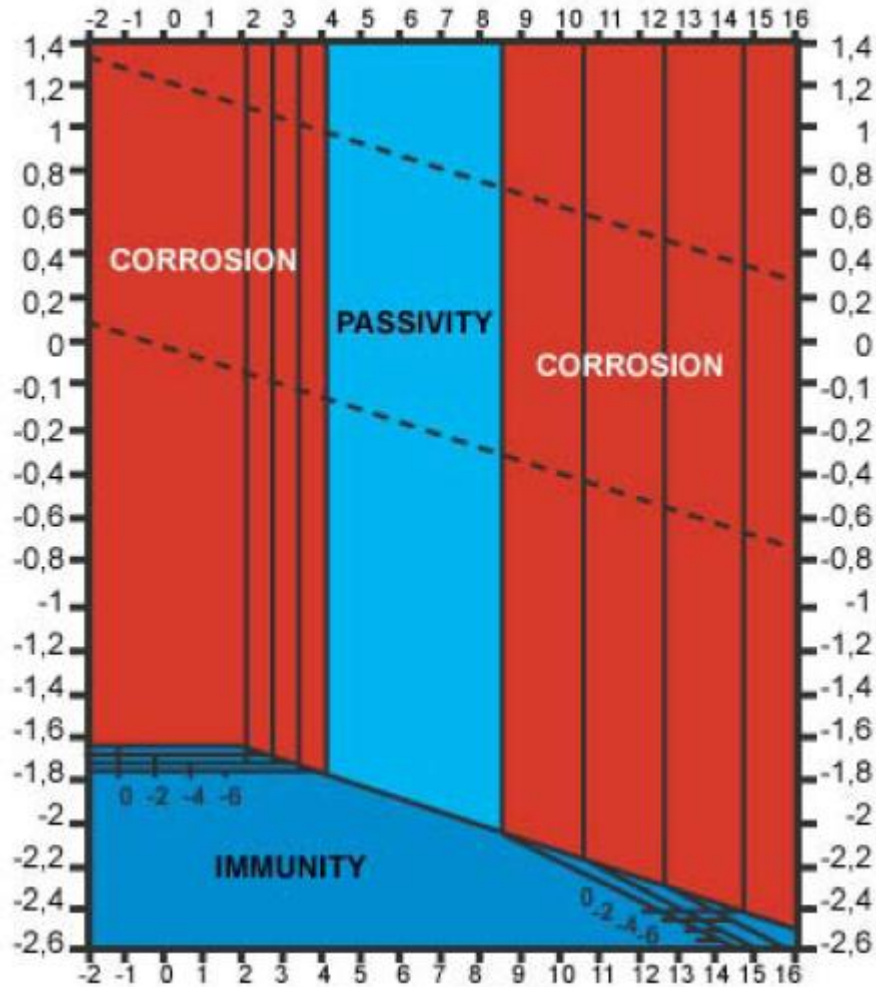

Corrosion of aluminium alloys



No magnesium anodes to protect hulls made of Al alloys

Corrosion Management in the Oil & Gas Industry

CP and associated coatings Applications

Cathodic Protection in Oil & Gas Industry

- ◆ **In the oil industry, cathodic protection is widely used for the protection against corrosion, mainly for:**
 - **offshore platforms and all other submerged facilities,**
 - **buried or submerged flow-lines and pipelines,**
 - **well casings,**
 - **external side of storage tank bottoms,**
 - **inside of vessels, ballasts and storage tanks,**
 - **jetties and other coastal structures,**
 - **foundations of structures in contact with soil or water.**

Corrosion Management in the Oil & Gas Industry

**CP and associated coatings
Applications to structures in
contact with soil**

Air-exposed pipelines

- ◆ In some desert dry regions steel **may be left bare** without significant **atmospheric corrosion**
- ◆ Several pipelines have been installed **directly bare on the ground**, leading to difficulties to prevent corrosion at steel surface in contact with soil by CP
- ◆ Pipeline should be **preferably installed on slippers** to prevent contact with soil
- ◆ It is always better to coat and bury onshore pipelines



Buried Pipelines

Buried pipelines for transportation of petroleum products, gas and chemicals (in conjunction with a passive protection coating):

- most often using impressed current, sometimes completed by stray currents drainage systems
- systematically used and frequently mandatory
- mandatory in France for gas distribution networks (“arrêté” dated July 13, 2000) and now for pipelines transporting gas, liquid hydrocarbons and other dangerous products through the new arrêté dated Aug. 4, 2006.

External Corrosion Management of buried or immersed pipelines

- ◆ For a better efficiency of CP and often to ensure its feasibility, a **coating** is always applied on steel surface
- ◆ As long as coatings **remain bonded to steel** and CP correctly applied, **no corrosion risk**. Disbonding of coatings may prevent access of CP current to steel exposed to a corrosive electrolyte (renewal, presence of SRB,...) if it is not conductive and/or homogeneous enough: "**CP current shielding effect**"
- ◆ **No corrosion experienced so far in seawater** due to its high conductivity and homogeneity
- ◆ Many cases of failures on "conventional" coatings (**bituminous enamels, tapes**) and increasing number of cases of disbonding, some with corrosion, with **PE, HSS, FBE**

No disbonding, good protection

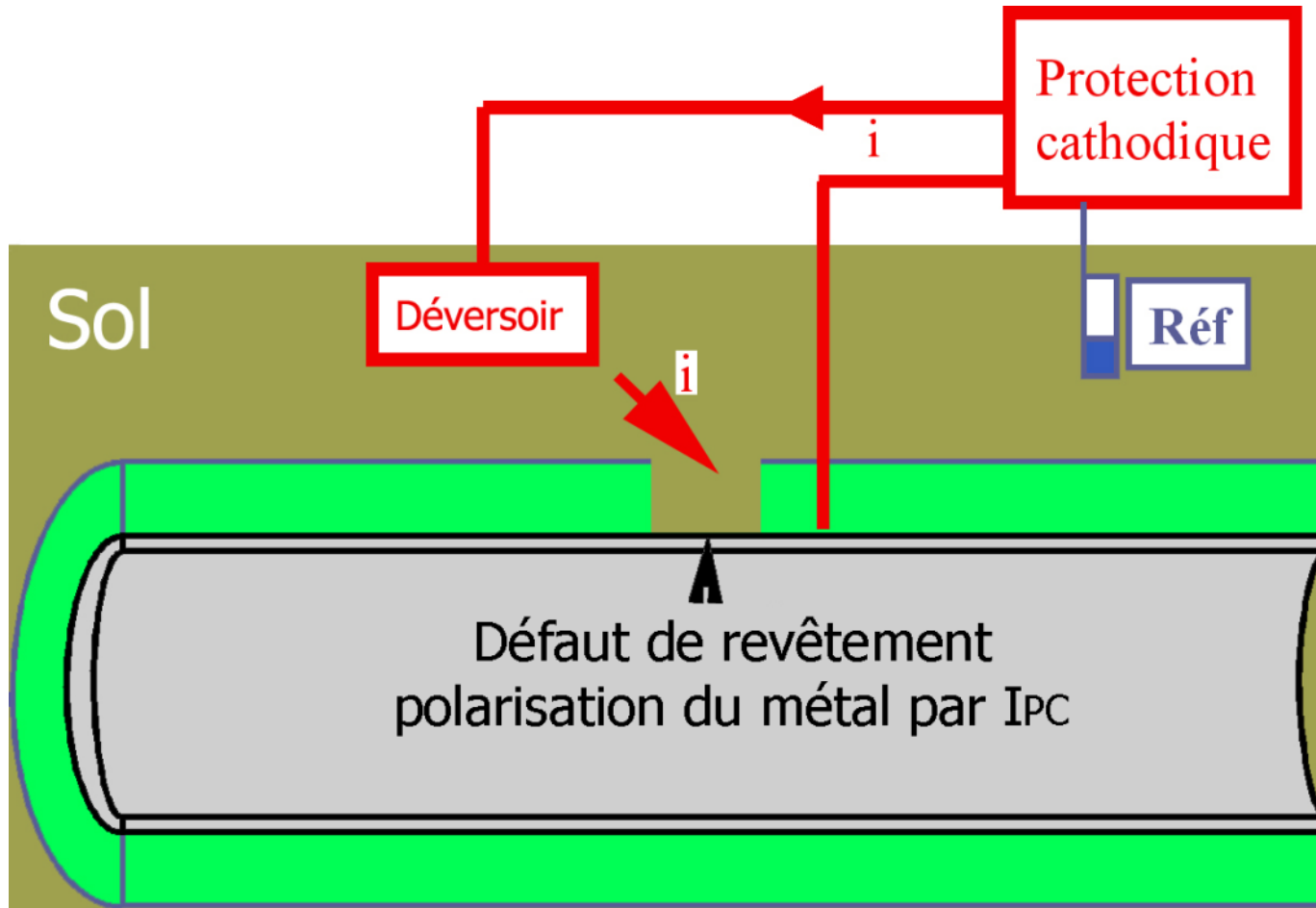

The "CP shielding effect" under disbonded coatings

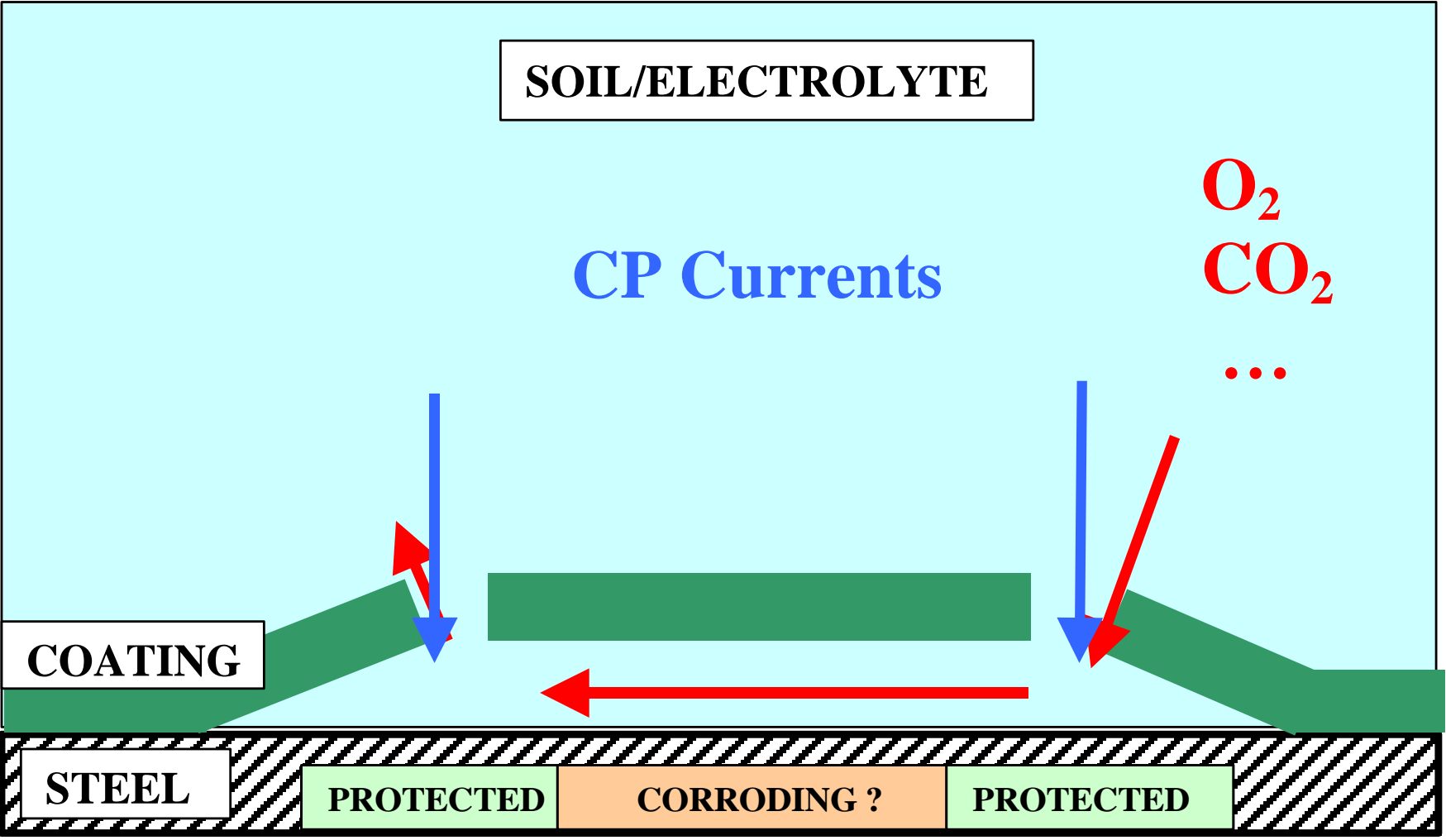

Basic Requirements for Pipeline Coatings

- ◆ Corrosion under disbonded coatings is **pernicious** because difficult to detect completely using the best CP inspection methods, the only safe way being intelligent pigging
- ◆ Consequently, enough care should be taken for the **selection and application of coating** to prevent disbonding
- ◆ This means that the coating should be **applied in a plant** on pipe lengths to ensure quality (surface preparation, hot application). It has to resist to handling, transportation and laying and to service conditions (especially maximum operating temperature)
- ◆ The **field joint coating** applied on girth weld areas after welding must be compatible with the plant coating and resist to service conditions
- ◆ Products, coating applicator and plant or field equipment and personnel must be **pre-qualified** to contribute to Quality

Experience with bituminous enamels

- ◆ **"Over-the-ditch" coatings** were used initially but abandoned more than 30 years ago due to the frequent bad quality of application, depending on the weather conditions
- ◆ plant applied coatings suffered from **mechanical brittleness**
- ◆ **corrosion under disbonded coatings was experienced** in various places
- ◆ **high temperature resistance** of bituminous enamels is highly controversial. Not reliable above 60 °C

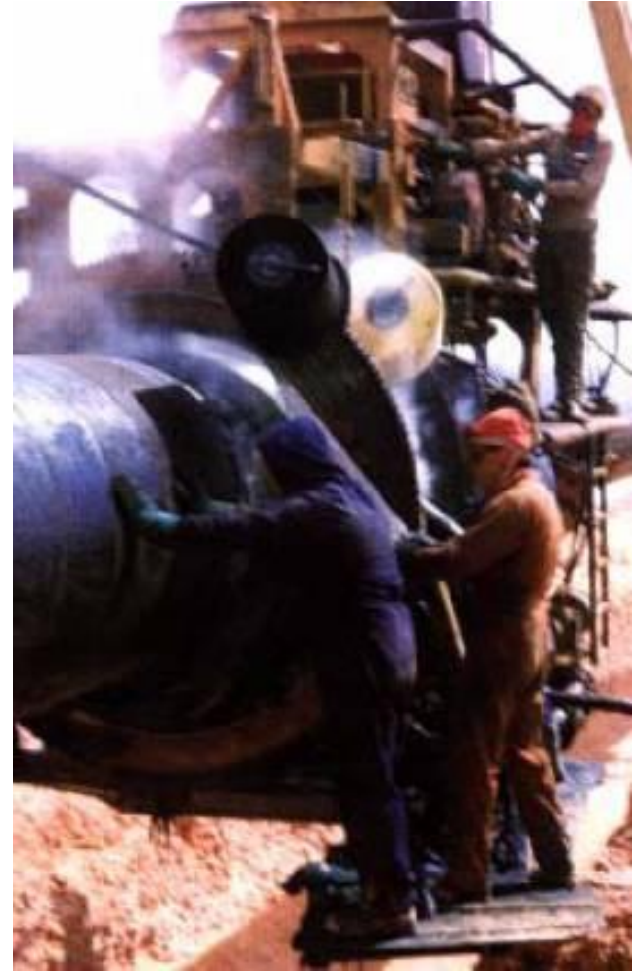

Corrosion under disbonded bituminous coating

Corrosion or Stress Corrosion Cracking

Iraq



Argentina

France

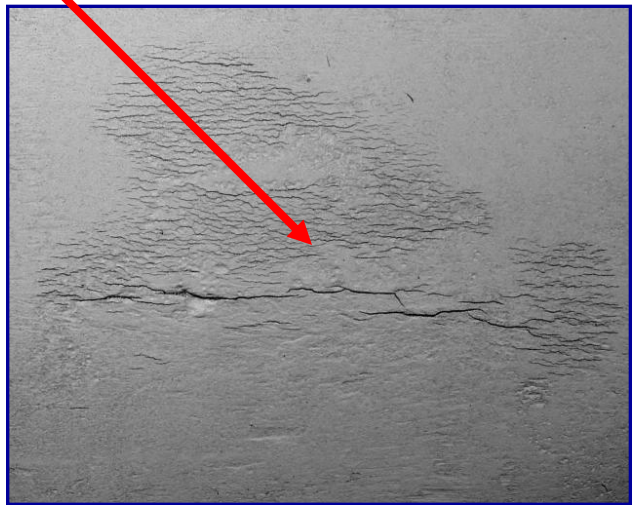

Experience with tapes and sleeves

◆ Cold applied tapes:

- when used over-the-ditch, same problems that with enamels due to bad quality of application
- **Severe corrosion and sometimes SCC under disbonded tapes**
- Tapes are now only used for some minor field joint coating projects or field repairs

◆ Heat shrinkable sleeves (HSS):

- widely used for field joint coatings, mainly when plant coating is PE
- fast curing liquid epoxy primer coating is now used to increase adherence to a better level in order to try to match with plant applied PE coating on pipe joints
- some high temperature sleeves are qualified, including for PP coating but PP reconstitution safer and often preferred
- **Many recent cases of corrosion** under disbonded HSS

Damaged tapes



Disbondment of HSS over steel and PE plant coating (corrosion)



18" Gabon (> 55°C, 15 years)



16" Syria (50°C, 12 years)



Disbonding and corrosion at HSS field joint coatings

◆ Disbonding of HSS due to:

- surface preparation by brush cleaning
- temperature effect

◆ Corrosion under disbonded HSS due to:

- penetration of water at **not bonded overlap** over 3LPE plant coating
- CP current shielding effect preventing CP
- Unsufficient level of true CP potential

Disbonding of field joint coatings: trends and actions

- ◆ **Sa 2,5 abrasive cleaning and epoxy primer for onshore application mandatory when HSS chosen**
- ◆ **Increased use of liquid applied PU or epoxy (e.g. Yemen LNG with 3LPE parent coating)**
- ◆ **Qualification by "Pull-off tests" (ISO 4624) after immersion in water at 23°C, 60°C and 80°C during 28 days**

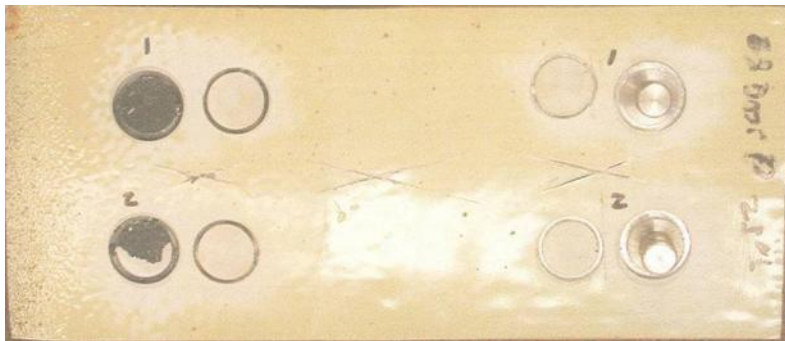

Experience with PE coatings

- ◆ PE coatings introduced in Europe 40 years ago, **monolayer (fusion of powder)**, followed by **2-layer extruded**: adherence problems encountered
- ◆ For offshore concrete coated pipelines, it is necessary to **improve shear strength** to avoid slipping in tensioners between PE and concrete
- ◆ An **epoxy primer** layer has been introduced at the end of the 70's to improve peeling strength of extruded PE coatings (>600 N/50mm) and cathodic disbonding : **3-layer coatings**
- ◆ Very good performance **until several problems of massive loss of adhesion** have been reported: **Increasing number of identified massive disbondments of 3LPE coatings (initially in India, South America, Iran, Pakistan)**

Disbonding of 3LPE coatings

Main common characteristics of failures:

- ◆ disbonding of **FBE on the steel surface**, often looking as just abrasive cleaned, always **without any significant corrosion**
- ◆ PE remains compressed on pipe, without gap
- ◆ identified only on **buried pipelines** (after cuts)
- ◆ comparison with spare pipes from the same production does not reveal loss of adherence
- ◆ **due to in-service conditions**: physico-chemical (soil, potential) or mechanical (stresses) parameters



Possible explanation of disbonding of PE

- ◆ water and oxygen diffusion through PE
- ◆ water saturation of FBE layer, depending on epoxy type ("**sensitivity**" to water)
- ◆ superficial corrosion of steel surface under water saturated FBE forming magnetite
- ◆ all steps accelerated by temperature
- ◆ **Presence of stress** in multilayer system may explain massive disbonding (as compared with FBE)

Experience with Three-layer Polypropylene (3LPP)

- ◆ introduced at the end of the 80's, mainly for **high temperature resistance**, due to failures with FBE above 90°C
- ◆ interesting also for **higher mechanical resistance** than 3LPE (selection for rough transportation conditions or rocky soils)
- ◆ adherence higher than 3LPE and maintained at high temperature (> 250N/50mm at 100°C)
- ◆ 1st use by Total in 1990 offshore Angola for temperature about 110°C
- ◆ no significant failure reported today but the risk of disbondment could be the same

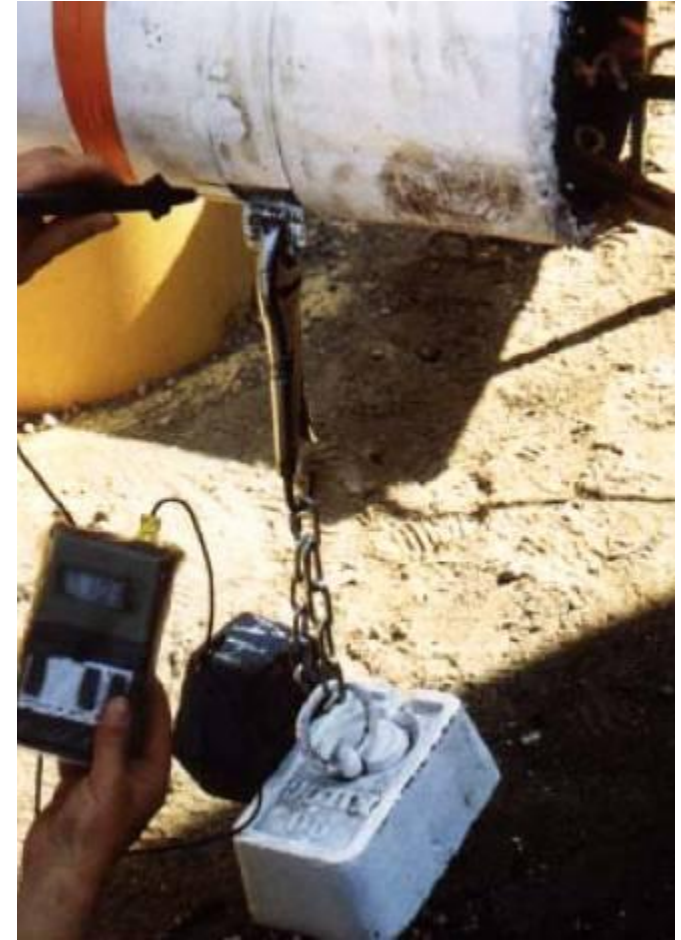

Experience with FBE

- ◆ Fusion-Bonded Epoxy coatings are the most current coatings used in several countries (USA, UK, ...)
- ◆ Thin coatings generally preventing important corrosion under disbonding
- ◆ However, case of corrosion under blistered FBE on an onshore buried pipeline in France (Temperature fluctuating between 40 and 100 °C, design MOT 100°C)



Impressed Current systems for soil applications

**Power source, e.g. T/R
(Transfo-rectifier)**

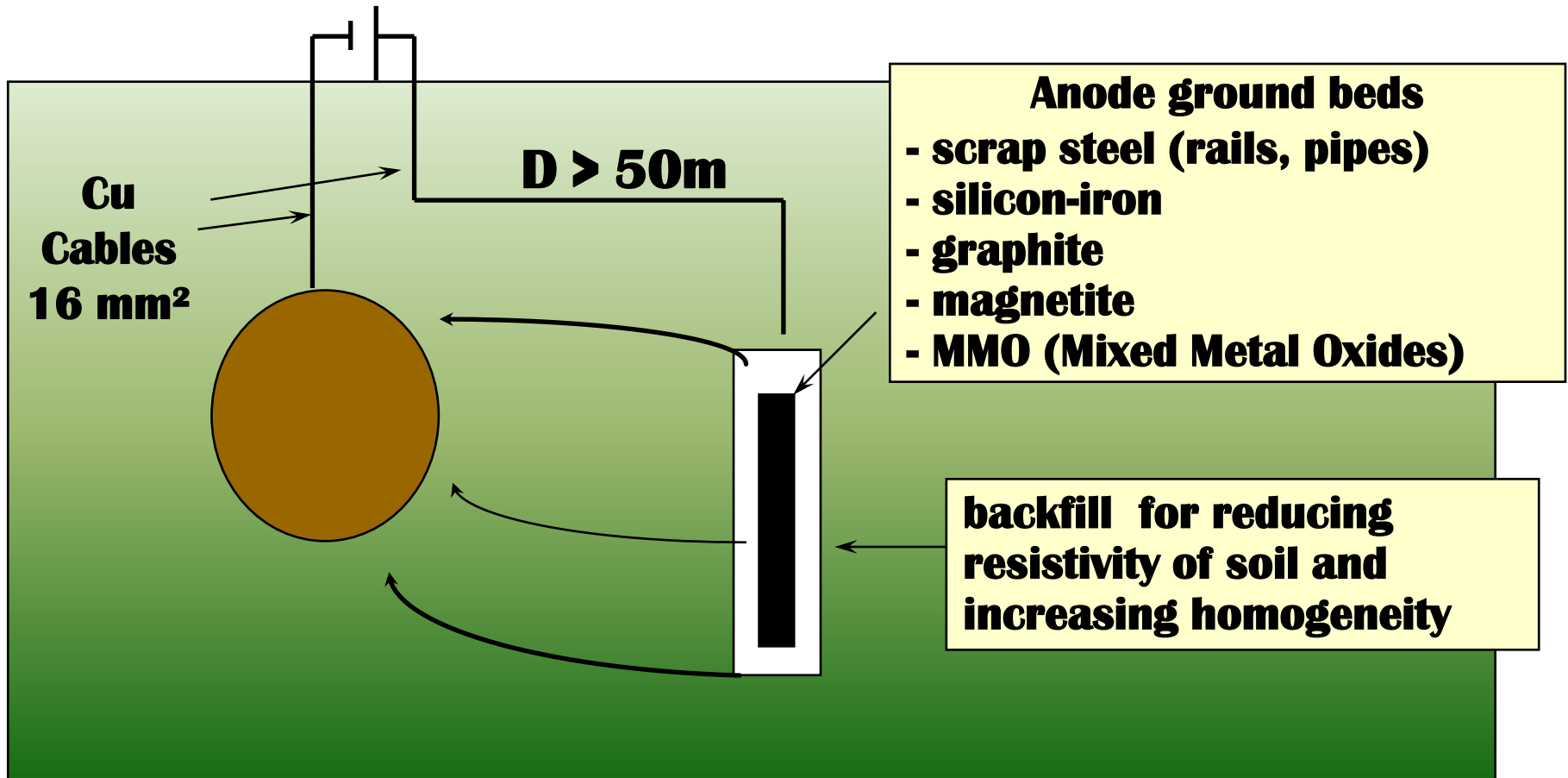

Impressed Current Cathodic Protection



Galvanic systems for soil applications

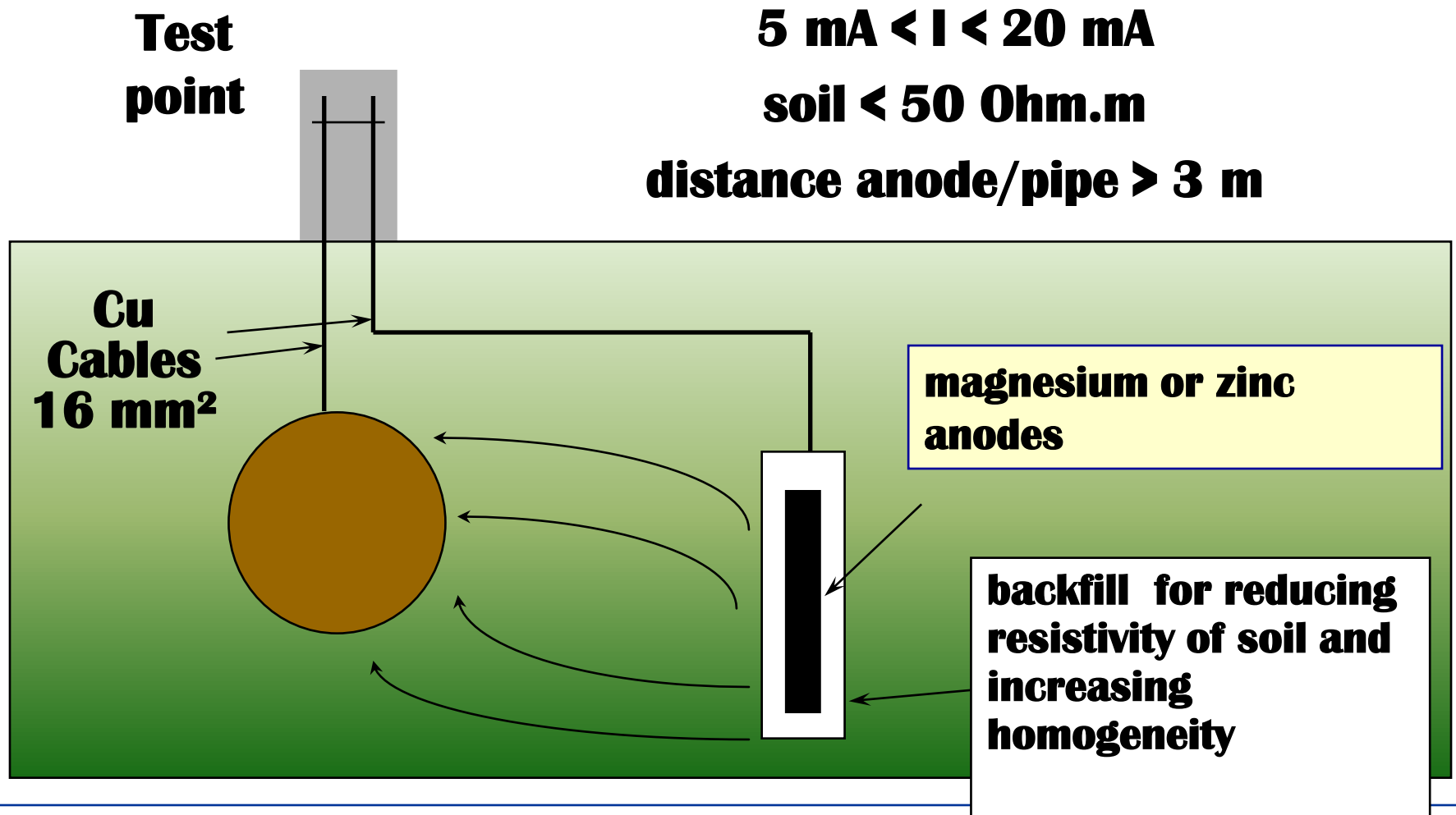

Galvanic systems for soil applications



Pre-backfilled magnesium anode

Piping, plants

◆ **buried piping in plants:**

- non systematic (e.g. for fire-fighting circuits)
- **trend to install long anodes for local protection in complex plants** (to concentrate protection and avoid interferences with other structures consuming current such as earthing circuits and concrete structures)

◆ **integral protection of plants:**

- pipings, bottoms of tanks, concrete foundations, earthing networks (general case, where they are not isolated from protected structures with approved devices). Use of deep anodes

Above-ground storage tanks

- ◆ CP of external side of bottom non systematic, depending on the nature of foundation.
- ◆ often difficult to achieve: shortage of CP current by **earthing networks made in bare Cu**. Better to use **galvanised steel** and/or insulated cables near tank
- ◆ not always 100 % efficient (imperfect contact between steel bottom and soil due to air trapped consecutive to phases when the tank is emptied)
- ◆ trend to install impervious membrane under tank bottom for prevention of pollution: **implementation of Ti (MMO) grid between bottom and membrane**

Above-ground storage tanks (without membrane)

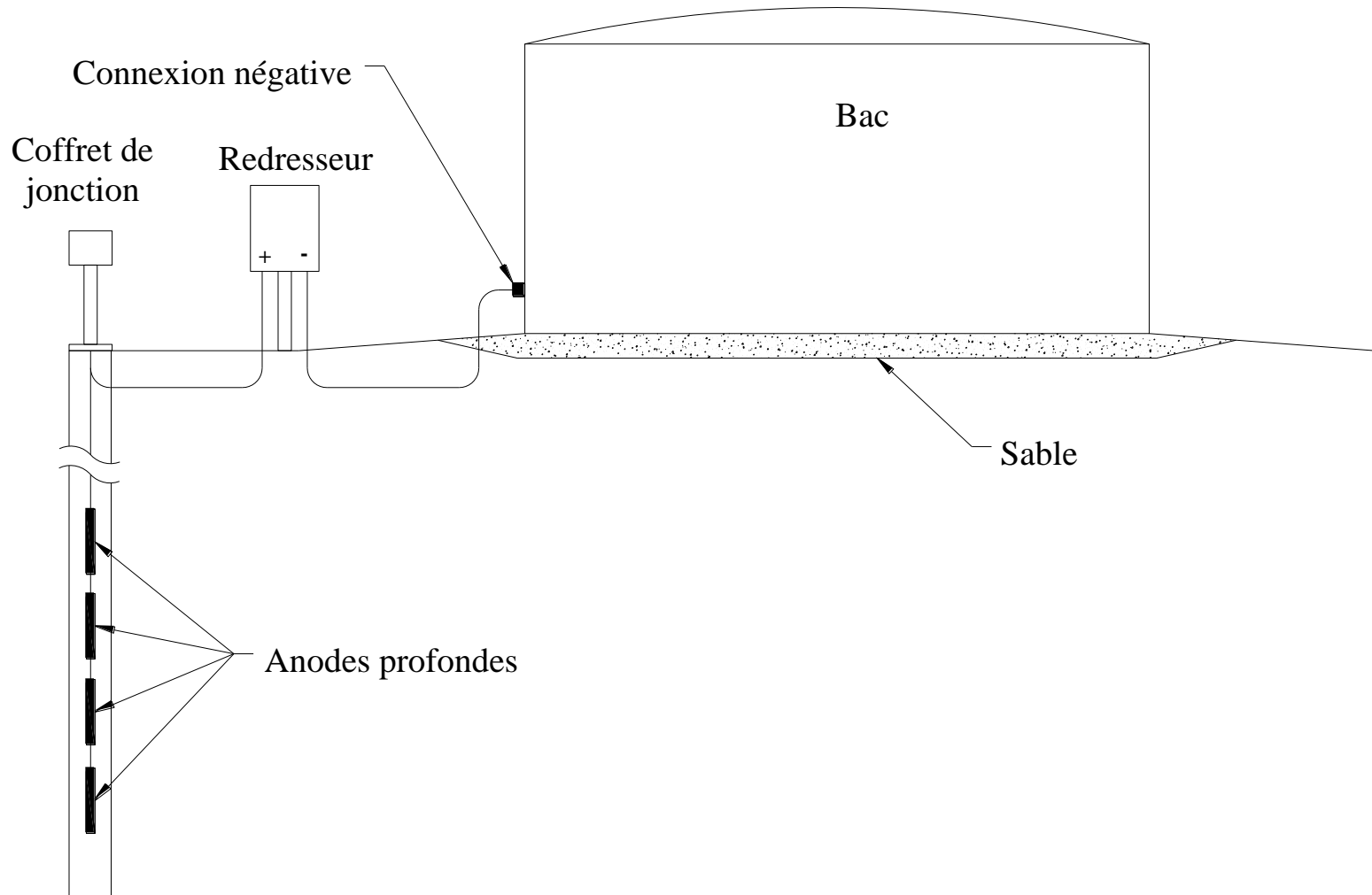

Above-ground storage tanks (with membrane)

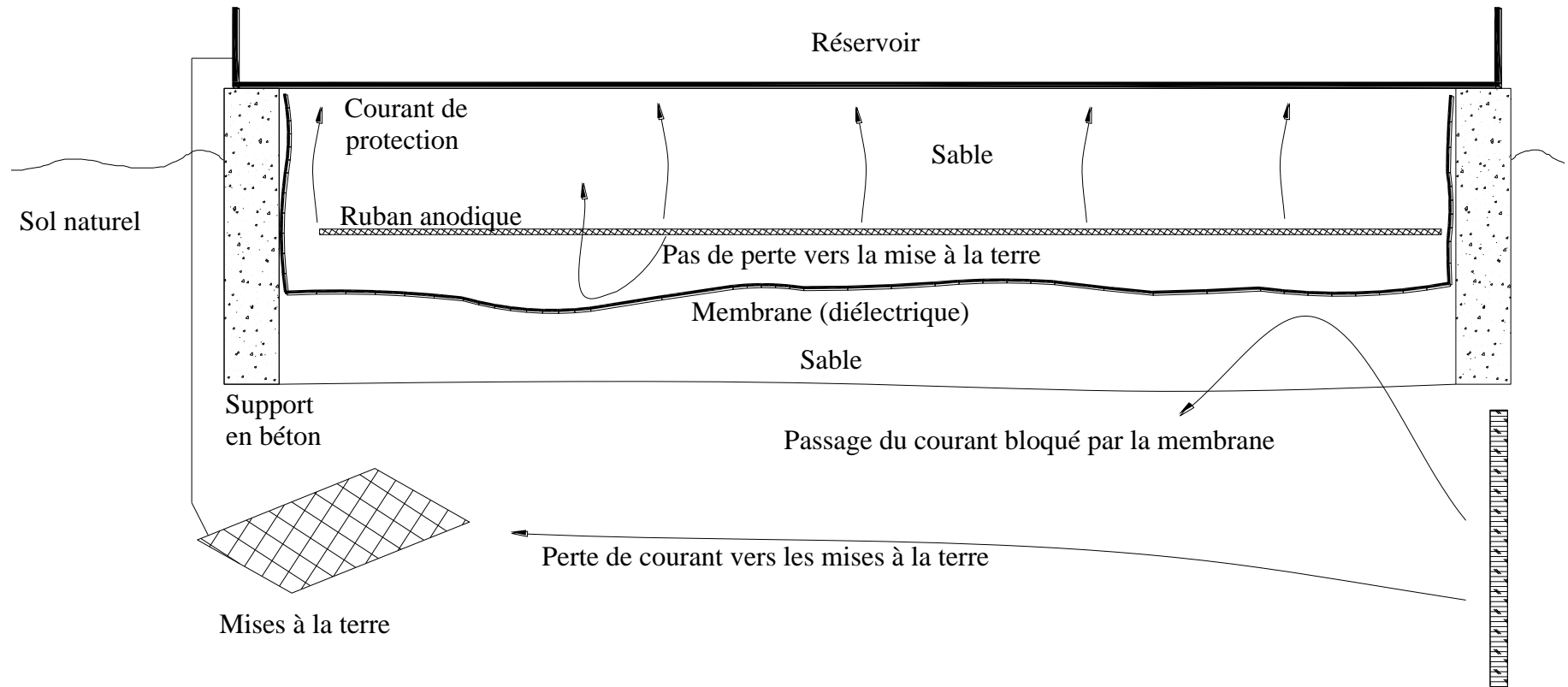

Trend to install a tight HDPE membrane under the bottom to prevent pollution: **Ti (MMO) mesh introduced between them**

Anode éloignée

Well casings

- ◆ **non systematic** for **onshore** wells
 - mainly when identified corrosion risks
 - or for long design lifetime (> 20 yr)
 - specific criteria to use
 - efficiency to be checked whenever possible from inside using CPT (Casing Potential Profile Tool)
- ◆ **always** for **offshore** wells (through electrical contact with the supporting platform or subsea template)
- ◆ 3 to 20 A (or more) necessary to protect a well

Structures in contact with soil: well casings

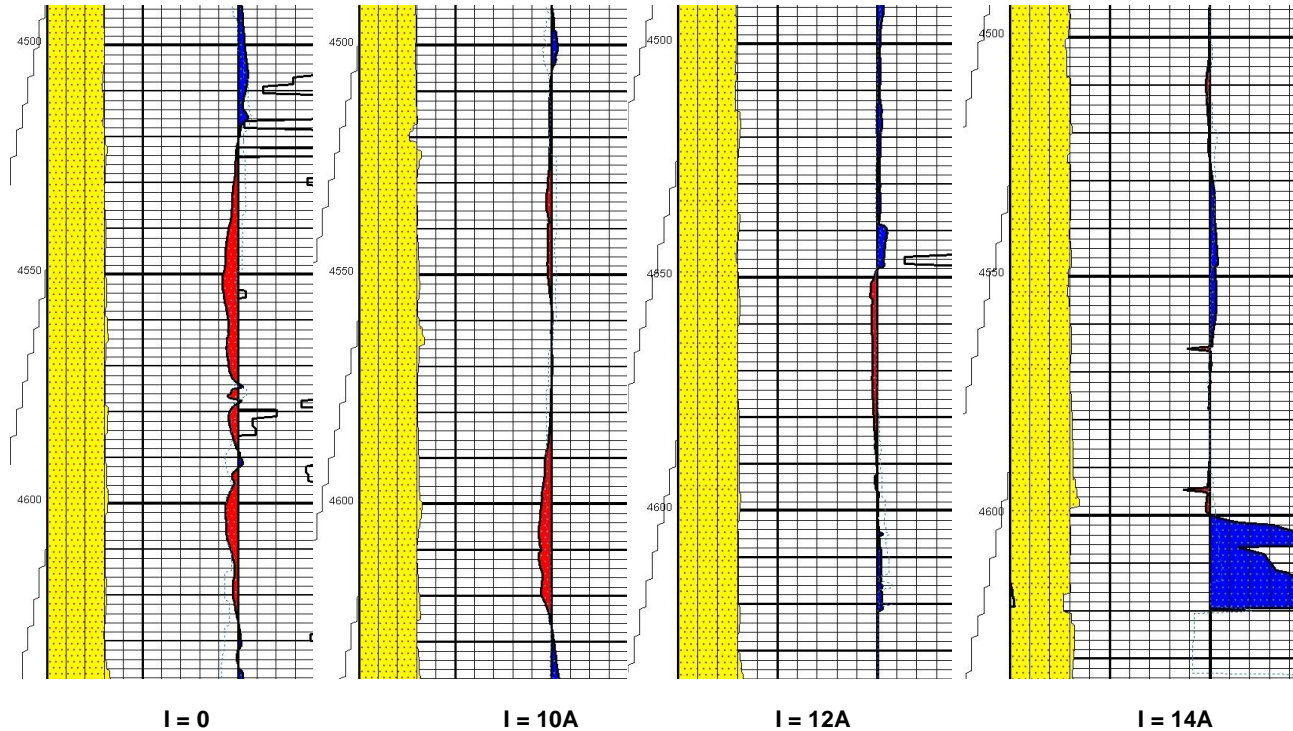

**Modification of "Corrosion Protection Evaluation Tool "CPET"
log as a function of increase of CP current applied to an
onshore well
(anodic areas in red, cathodic areas in blue)**

Corrosion Management in the Oil & Gas Industry

CP and associated coatings Applications to submerged structures

Pipelines

◆ **coastal pipelines** (storage facilities of petroleum products, oil loading terminals:

systematic, impressed current from the shore or galvanic anode-bracelets

◆ **offshore pipelines:**

systematic, mainly using galvanic anode-bracelets (Al has replaced Zn when reliability has been proven)



Anode-bracelets for offshore pipelines

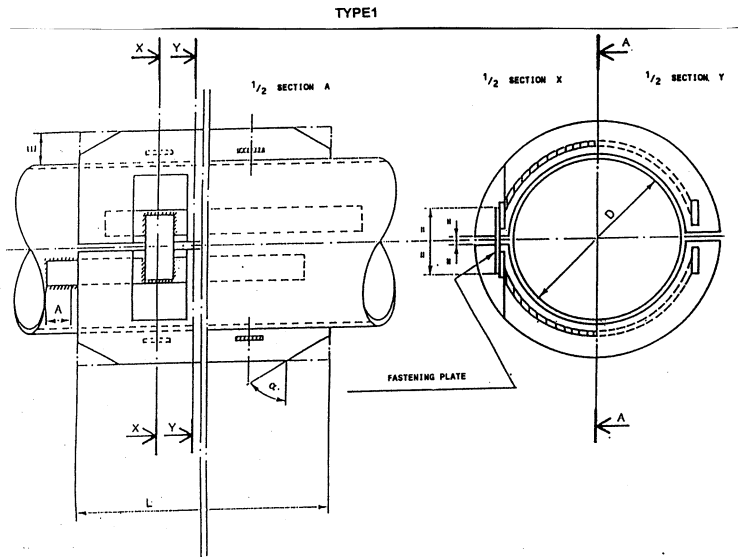

Electrical connection:

- with cables (risk of failure)
- By welding of lugs (better)

TYPE2

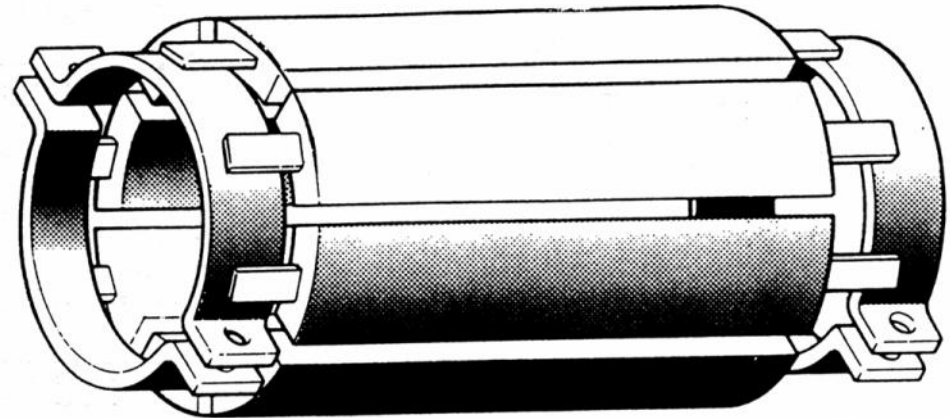
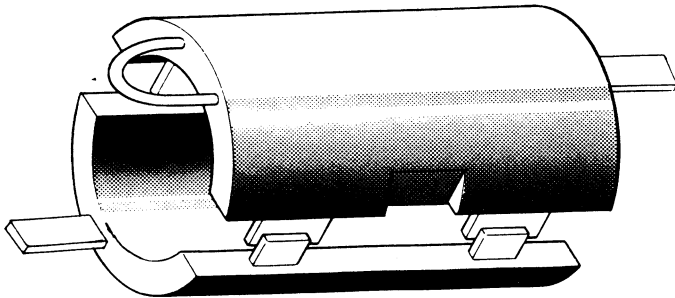

Anode-bracelets for offshore pipelines



Experience with riser coatings (offshore)

- ◆ Coatings to be especially mechanically resistant for tidal and splash zone offshore conditions
- ◆ 8mm thick **Fiberglass Reinforced Epoxy** coating has been used with success mainly in Gulf of Guinea and North Sea
- ◆ **Elastomeric coatings** (mainly polychloroprene, sometimes EPDM for higher temperatures) constitute the conventional solution used world wide. Bonding is critical to achieve (2 bonding agents are necessary)
- ◆ Several cases of disbondments with corrosion at the upper end have been noticed after 20 yr for both coatings
- ◆ **HSE** rules of Total require that risers transporting flammable products are protected by "**Passive Fire Protection**" (PFP) from water level up to ESDV .

Corrosion underneath offshore riser coatings in the transition zone



**Fiberglass reinforced epoxy,
Gabon**



Polychloroprene, Argentina

Sea water submerged structures: various

◆ offshore fixed platforms and subsea production facilities:

- systematic, mainly galvanic anodes (Al alloys), without coating in the case of "jackets"

◆ harbour facilities, buoys :

- non systematic

◆ tankers, ships, mobile drilling platforms:

- systematic, impressed current or galvanic anodes depending on size and use

Anodes for a "jacket"

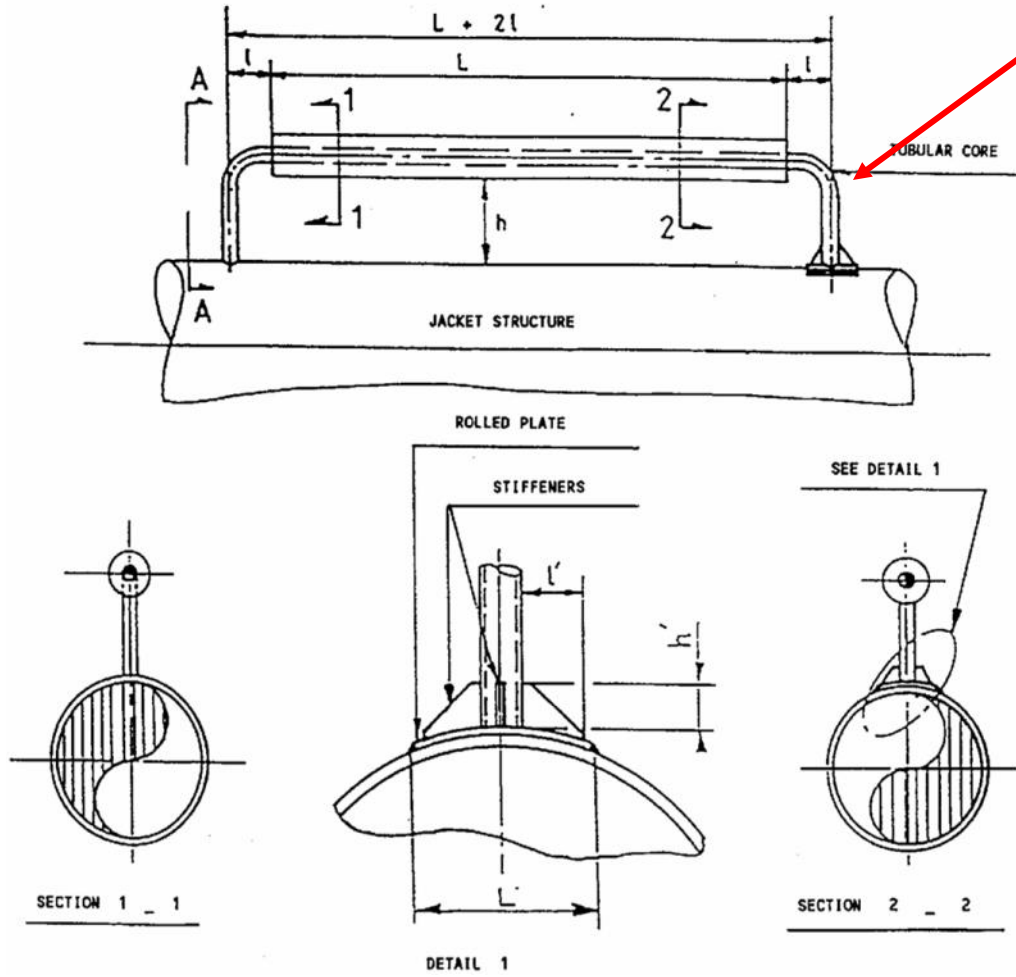

"stand-off" with external elbows to be preferred for safety

Anodes on a "jacket" in construction



Anodes on a "jacket" during transportation on site



Anodes on a "jacket"

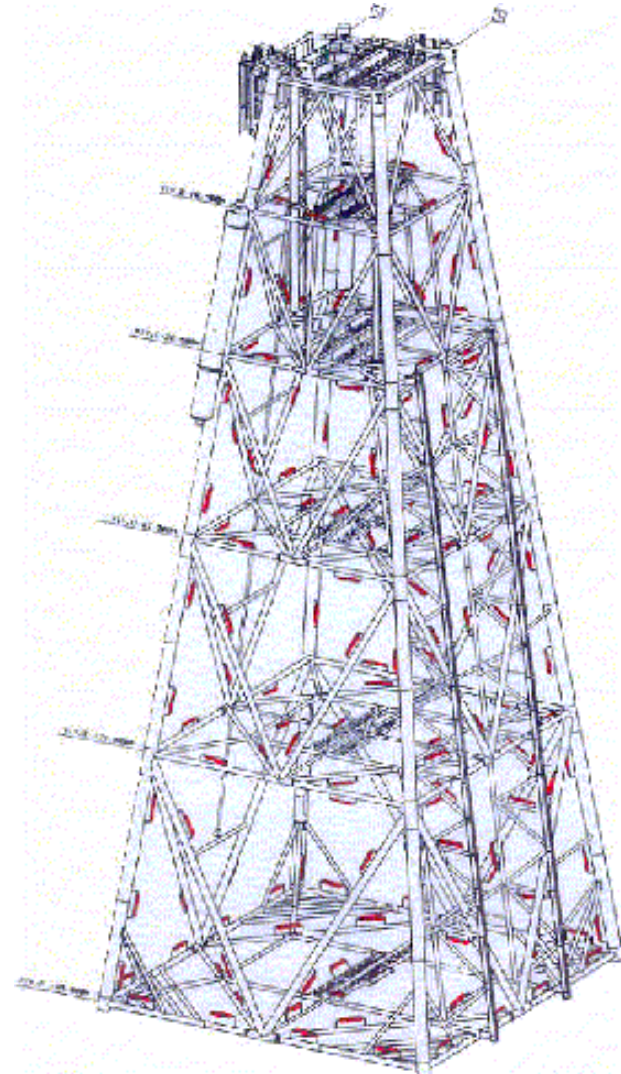
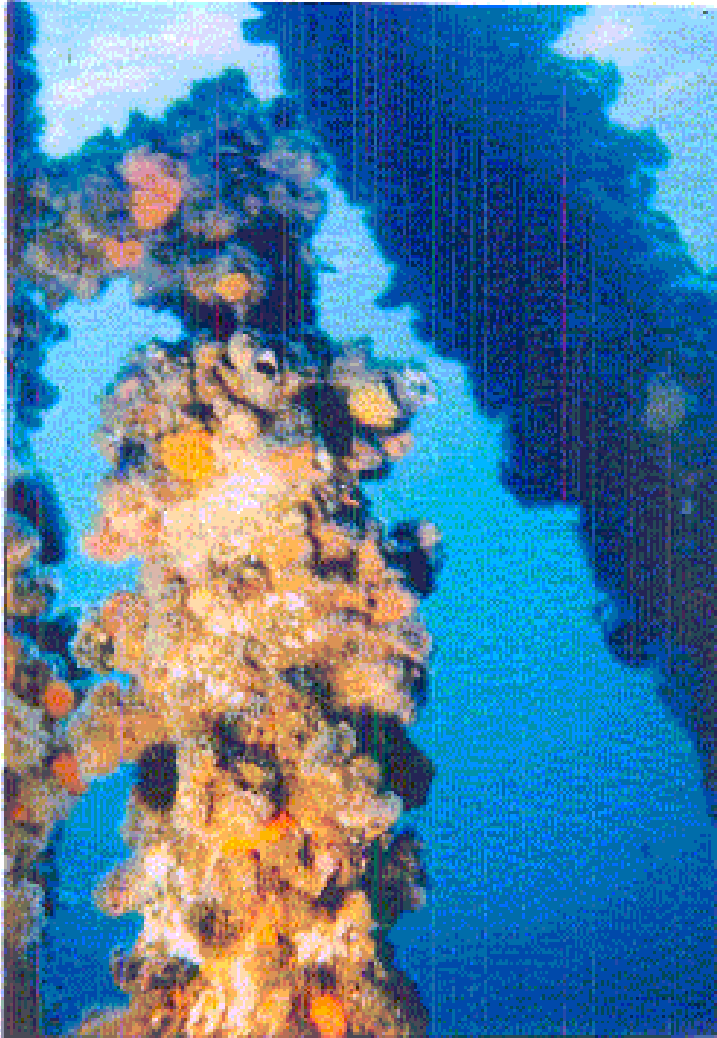

Consumed anodes on a "jacket" after recovery



Type of
"stand-offs"
to be
avoided for
safety of
divers

Anodes for hulls



Anodes protecting a complex system

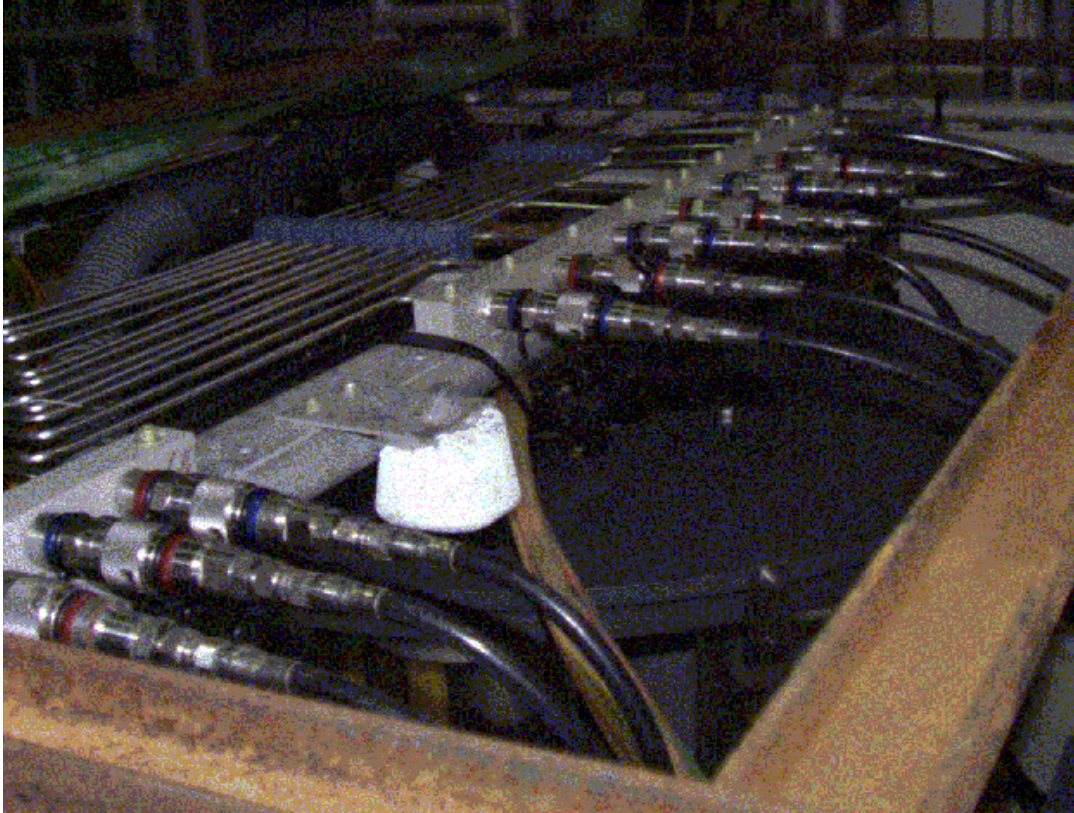

The major issue is to **ensure and check that electrical continuity** between all items is achieved, some of them being made of stainless steels (presence of coatings and non metallic items)

Corrosion Management in the Oil & Gas Industry

CP and associated coatings

**Applications to internal of
apparatuses**

Internals of capacities

- ◆ in conjunction with coatings
- ◆ bottoms of tanks when enough separated water, using galvanic anodes (Zn or Al)
- ◆ seawater ballasts and oil cargo tanks on tankers and FPSO's: more or less systematic
- ◆ oil / gas / water flow separators and desaltors: more and more used (galvanic anodes)
- ◆ water boxes of heat-exchangers and filters with seawater: frequent



Corrosion Management in the Oil & Gas Industry

Cathodic Protection

Applications to reinforced concrete structures

Concrete reinforced and prestressed structures

- ◆ **preventive or curative CP**
- ◆ it is of utmost importance to ensure as much as possible electrical continuity in the steel rebars skeleton and to provide a contact with the protective current return electric cable
- ◆ **buried concrete structures** (water pipelines, foundations plant equipment, ...) : technology is identical to this used for buried steel structures
- ◆ **immersed concrete structures** (platforms, harbour facilities): technology is identical to this used for buried steel structures

Concrete reinforced and prestressed structures

- ◆ air-exposed concrete structures (decks or piles of bridges, supports, buildings, ...): **technology has to be adapted for embedding** galvanic or impressed current anodes in the concrete surface. Impressed current has better experience.



Titanium anode for CP in concrete

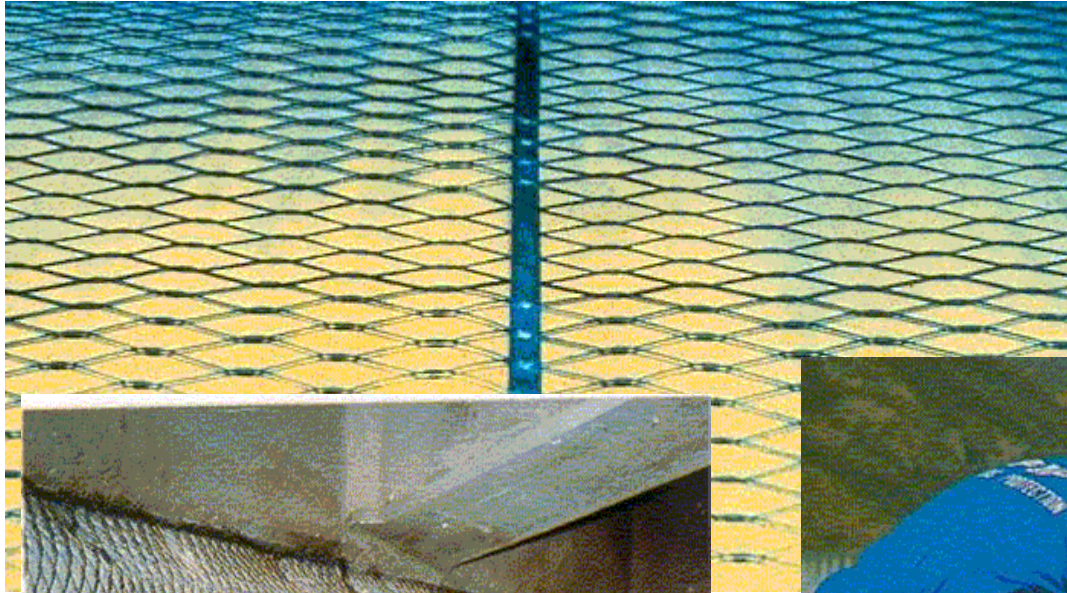

Zinc anode: sprayed or pre-glued foils

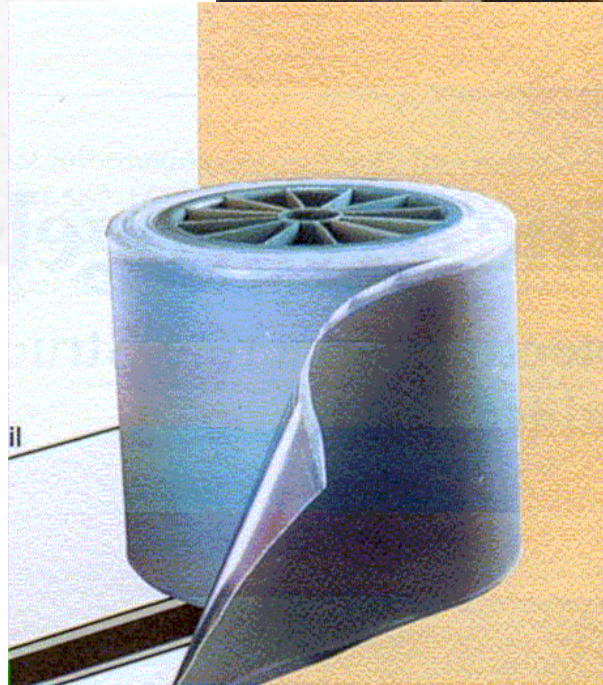
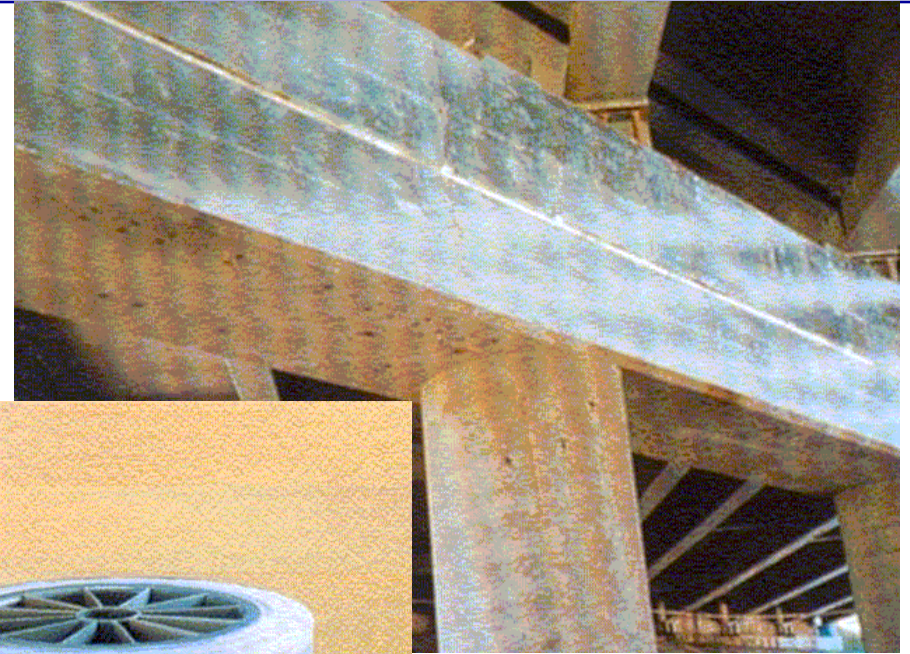

Anodes inside concrete, impressed current or zinc

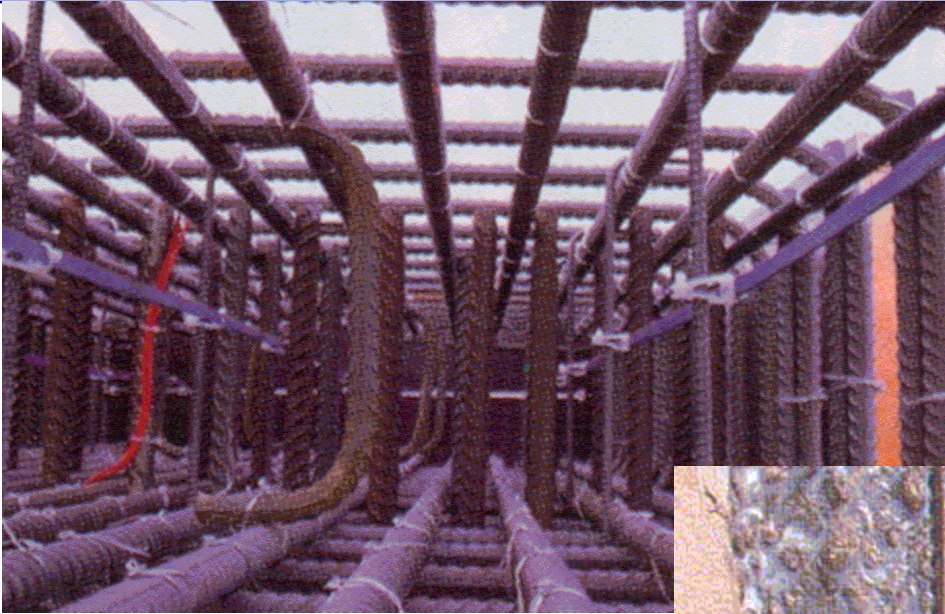

TPA Training Course

Corrosion Management in the Oil & Gas Industry

End of Part 3